

Amana LWC90AW (BOM: PLWC90AW) 08 - MIXING VALVE AND HOSE

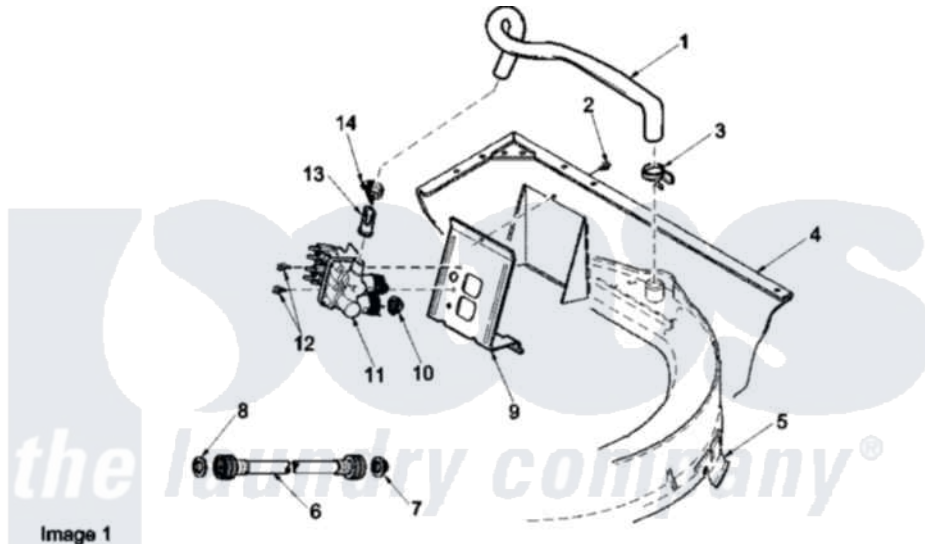

Image 1

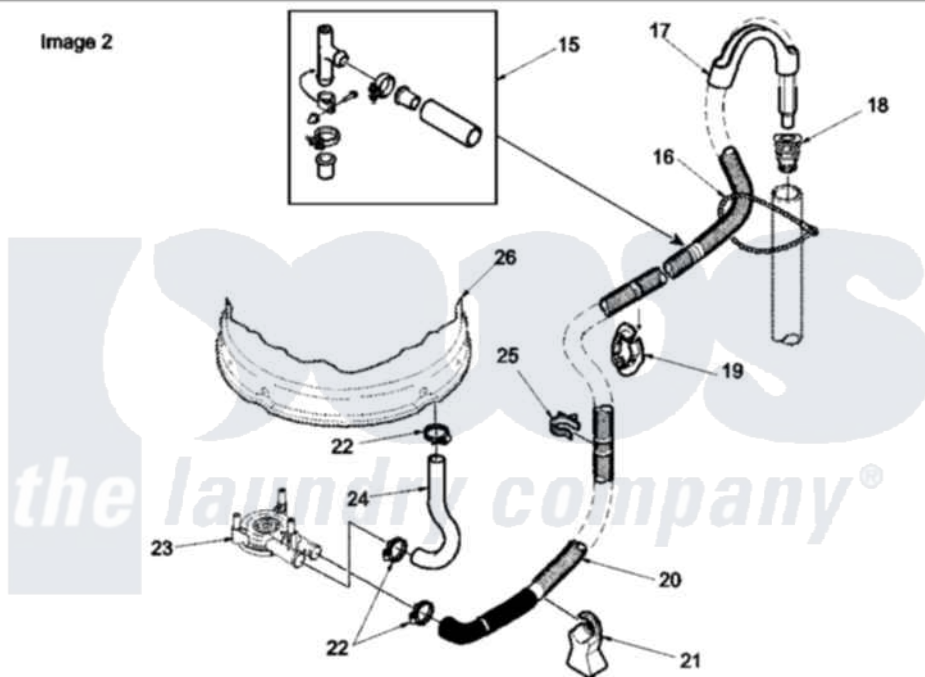

Image 2

Amana Residential Amana LWC90AW (BOM: PLWC90AW) Washer Parts Parts Diagram 08 - MIXING VALVE AND HOSE

[Click on the part number to view part](#)

Item	Original Part Number	Replaced By	Status	Part Description
1	38155			Hose, Mix Valve To TU
2	503661	27001200		Screw
3	29210			Hose Clamp
4	34475WP	38612WP		Kit-Servic
5	37502	39169		Assembly Tub Cover Gasket And Channel
6	28330P	202860		Inlet Hose Assembly
"	20618	21001467		Hose- 10'
"	20617		Not Available	HOSE, INLET (8 FT)
7	28605	22002960		Strainer, Washer Inlet
8	20290	Y013783		Washer, Inlet Hose
9	34972	39407		Bracket, Valve
10	24122	22002960		Strainer, Washer Inlet
11	38495	R0131578		Valve-Inlet
12	501086	90767		Screw, 8A X 3/8 HeX Washer Head Tapping

13	34500	22001900	Preventer, Back Flow
14	36801	596669	Clamp, Manifold
15	562P3	76660	Break-Sphn
16	33489	8539404	Tie-Wire
17	33615	22003814	Retainer, Drain Hose
18	36878	40008101	Adapter, Standpipe
19	32219		Relief, Strain
20	38062	40053901	Hose, Drain
21	38732	40044901	Stand, Hose
22	36802	285655	Clamp, Hose
23	36863P	27001233	Pump
24	38351	40094201	Hose, Tub To Pump
25	36014		Clip, Retainer-Hose
26	Y00000000	Not Available	SEE NOTE SEE NOTE OUTER TUB

