

Amana LWM353W (BOM: P1176401W W) 12 - MIXING VLV & MTR CONN BLOCKS/TERM & TOOL

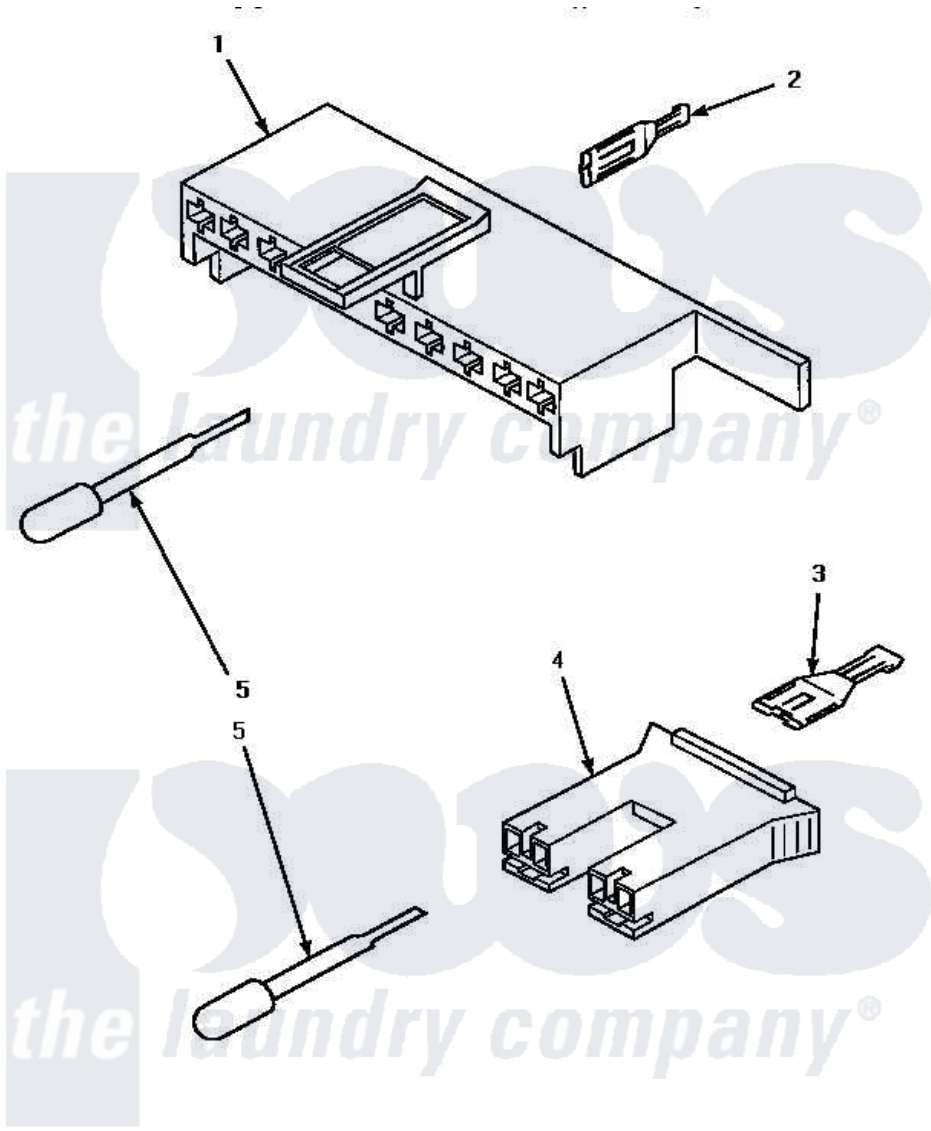

MIXING VALVE AND MOTOR CONNECTION BLOCKS, TERMINALS AND TERMINAL EXTRACTOR TOOL

Amana [Residential Amana LWM353W \(BOM: P1176401W W\) Washer Parts](#) Parts Diagram 12 - MIXING VLV & MTR CONN BLOCKS/TERM & TOOL

[Click on the part number to view part](#)

Item	Original Part Number	Replaced By	Status	Part Description
1	34677			10 Circuit Plug
2	Y00188			Molex Terminal
3	Y00121		Not Available	SPADE TERMINAL(12 GAUGE) (1/4 INCH-(2) 18 GAUGE WIRES O
4	34676			Plug
"	34675		Not Available	PLUG
5	283P4			Terminal Extractor Tool