

Amana NA3312 19 - TRANSMISSION ASSY & BALANCE RING

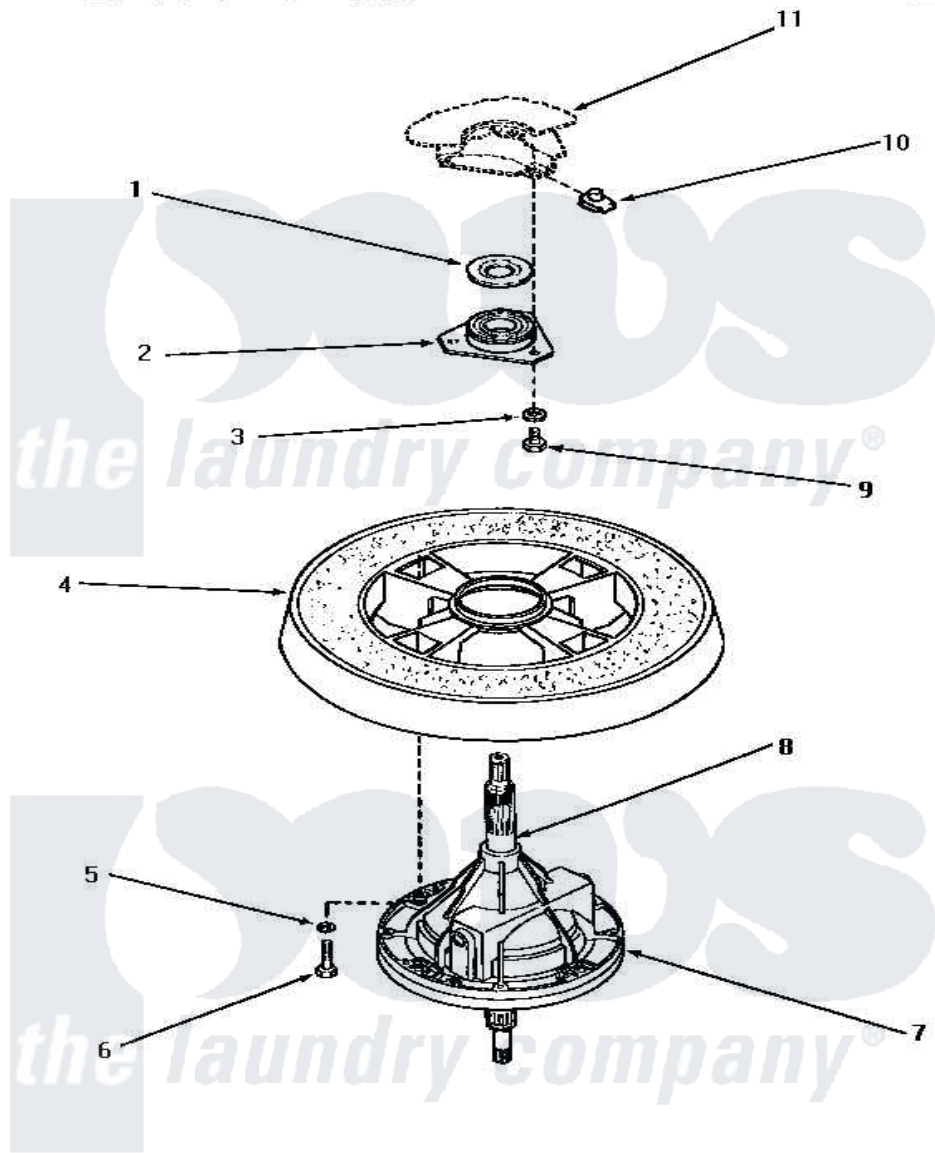

TRANSMISSION ASSEMBLY AND BALANCE RING

Amana Residential Amana NA3312 Washer Parts Parts Diagram 19 - TRANSMISSION ASSY & BALANCE RING
 Click on the part number to view part

Item	Original Part Number	Replaced By	Status	Part Description
1	27187			Flinger
2	27182	40004201P		Main Bearing Assembly
3	04366			Lockwasher, 5/16intshkp
4	Y29117		Not Available	ASSY, BALANCE RING-COMPL
5	02431			Lockwasher, 1/4 Ext Shk
6	27200		Not Available	CAP SCREW
7	33227	33227P		Assembly- Tran
8	27604P			Never-Seeze 1 Oz Tube
9	01355		Not Available	SCREW
10	27222			Nut, Retainer 5/16-18
11	Y00000000		Not Available	SEE NOTE OUTER TUB