

# Amana NA3510 10 - LOADING DOOR SWITCH & BRACKET ASSY

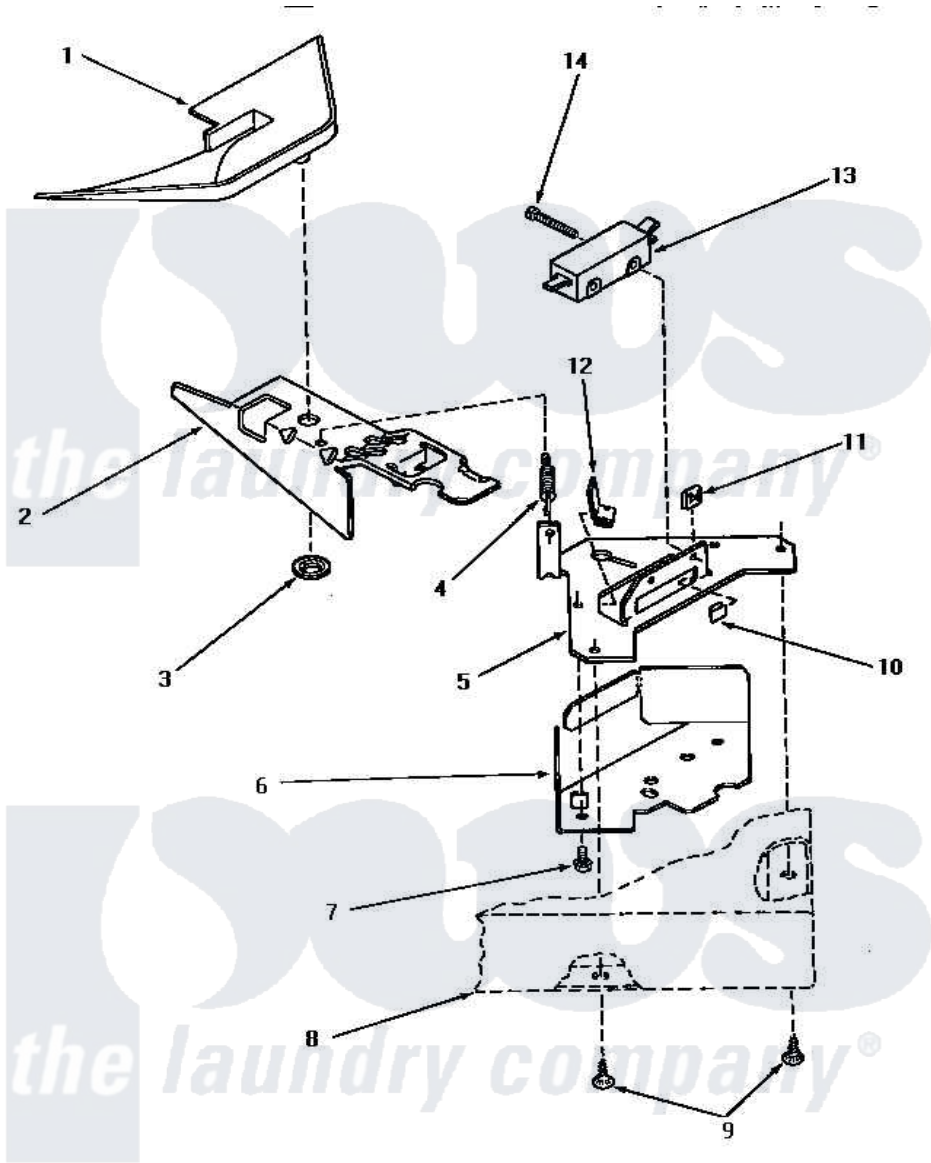

## LOADING DOOR SWITCH AND BRACKET ASSEMBLY

Amana [Residential Amana NA3510 Washer Parts](#) Parts Diagram 10 - LOADING DOOR SWITCH & BRACKET ASSY  
 Click on the part number to view part

Item	Original Part Number	Replaced By	Status	Part Description
1	29042		Not Available	SHIELD,LID SWITCH
2	<a href="#">27602</a>			Lever, Out-Of-Bal Switch
3	<a href="#">29043</a>			Nut, Push
4	<a href="#">27603</a>			Spring, Switch Lever
5	27250		Not Available	BRACKET,OUT-OF-BAL SWI
6	33086		Not Available	ENCLOSURE,LID SWITCH
7	23222	<a href="#">3177991</a>		Screw
8	Y00000000		Not Available	SEE NOTE CABINET TOP
9	<a href="#">28193</a>			Screw, 8-1/2 Tapping W/
10	<a href="#">27610</a>			Clip, U
11	27248		Not Available	NUT,SPEED U-TYPE
12	<a href="#">Y27837</a>			Clip, Speed-"U" Type
13	27249		Not Available	SWITCH
14	Q6516		Not Available	SCREW,6-32 X 1 ROUND H