

Amana NA3512 10 - LOADING DOOR SWITCH & BRACKET ASSY

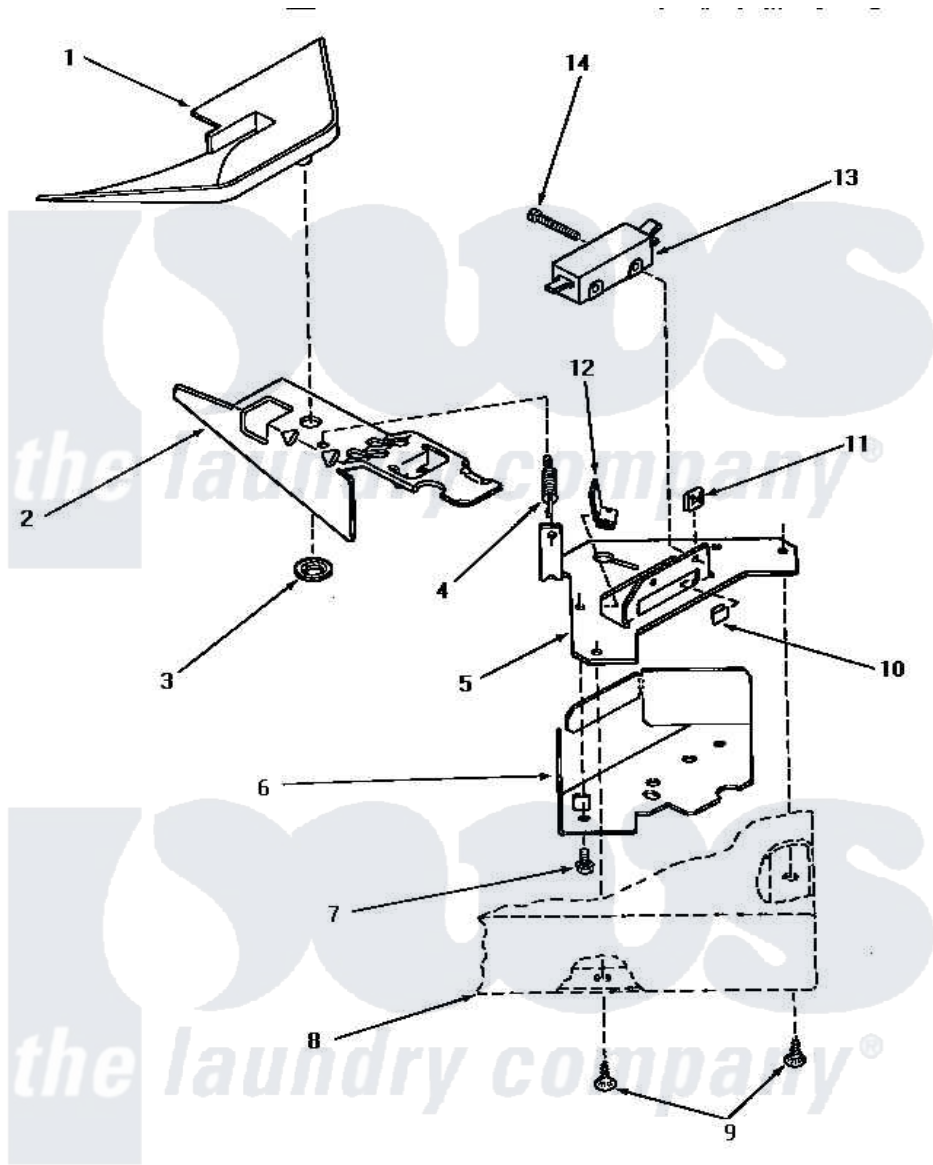

LOADING DOOR SWITCH AND BRACKET ASSEMBLY

Amana [Residential Amana NA3512 Washer Parts](#) Parts Diagram 10 - LOADING DOOR SWITCH & BRACKET ASSY
 Click on the part number to view part

| Item | Original Part Number | Replaced By | Status | Part Description |
|------|------------------------|-------------------------|---------------|--------------------------|
| 1 | 29042 | | Not Available | SHIELD,LID SWITCH |
| 2 | 27602 | | | Lever, Out-Of-Bal Switch |
| 3 | 29043 | | | Nut, Push |
| 4 | 27603 | | | Spring, Switch Lever |
| 5 | 27250 | | Not Available | BRACKET,OUT-OF-BAL SWI |
| 6 | 33086 | | Not Available | ENCLOSURE,LID SWITCH |
| 7 | 23222 | 3177991 | | Screw |
| 8 | Y00000000 | | Not Available | SEE NOTE CABINET TOP |
| 9 | 28193 | | | Screw, 8-1/2 Tapping W/ |
| 10 | 27610 | | | Clip, U |
| 11 | 27248 | | Not Available | NUT,SPEED U-TYPE |
| 12 | Y27837 | | | Clip, Speed-"U" Type |
| 13 | 27249 | | Not Available | SWITCH |
| 14 | Q6516 | | Not Available | SCREW,6-32 X 1 ROUND H |