

# Amana NA3612 03 - AGITATOR, DRIVE BELL & SEAL KIT

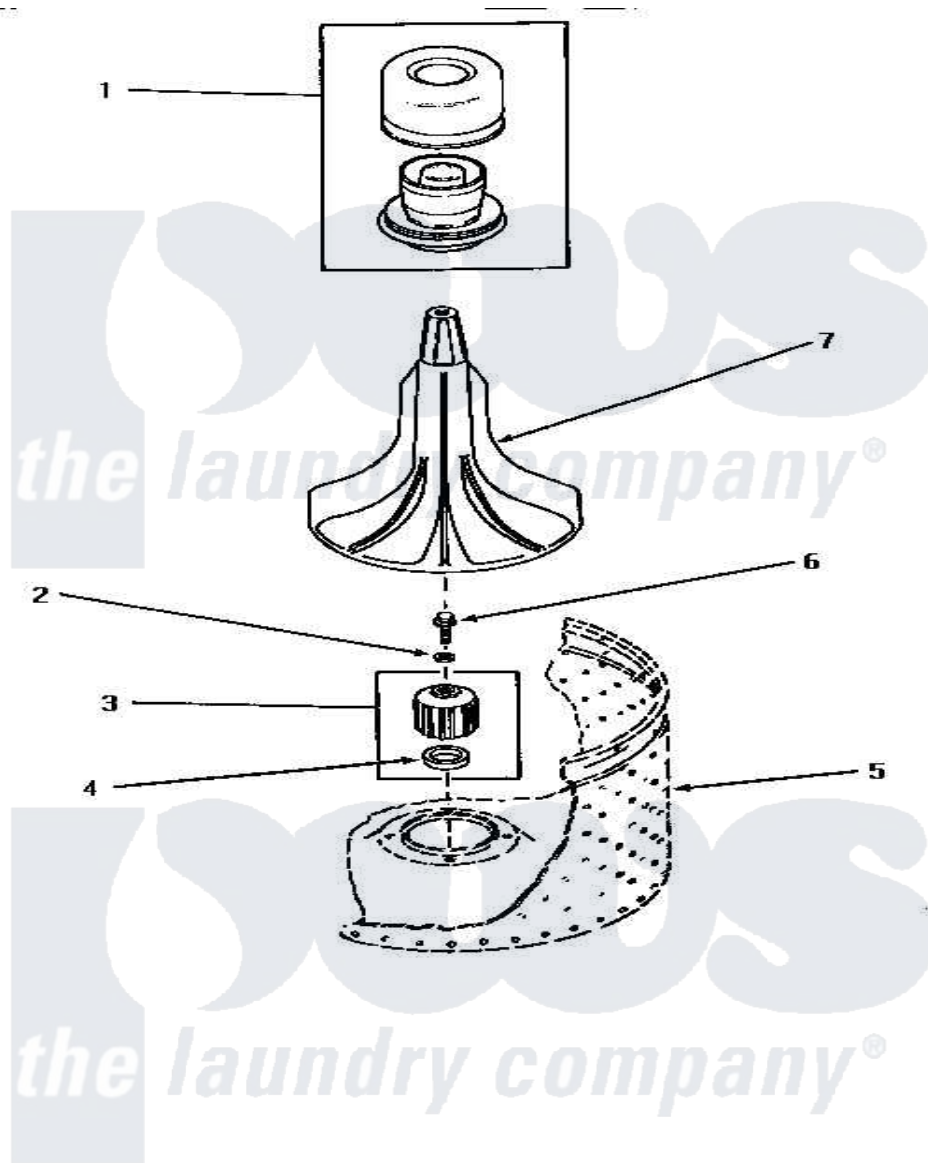

## AGITATOR, DRIVE BELL AND SEAL KIT

Amana [Residential Amana NA3612 Washer Parts](#) Parts Diagram 03 - AGITATOR, DRIVE BELL & SEAL KIT  
 Click on the part number to view part

Item	Original Part Number	Replaced By	Status	Part Description
1	30857	<a href="#">33510</a>		Assembly, Dispenser-Fabric
2	30853		Not Available	SEAL
3	30071P	<a href="#">R9900189</a>		Kit, Drive Bell And Seal
4	Y00000000		Not Available	SEE NOTE SEAL SEAT
5	Y00000000		Not Available	SEE NOTE WASHTUB
6	<a href="#">30852</a>			Screw, No.8-1/4 X 20 X 3/
7	30855	<a href="#">40000501W</a>		Agitator, Flex Vane
NI	442P3	<a href="#">R9900189</a>		Kit, Drive Bell And Seal