

# Amana NA6522 15 - POWER CORD & WIRE TERMINALS

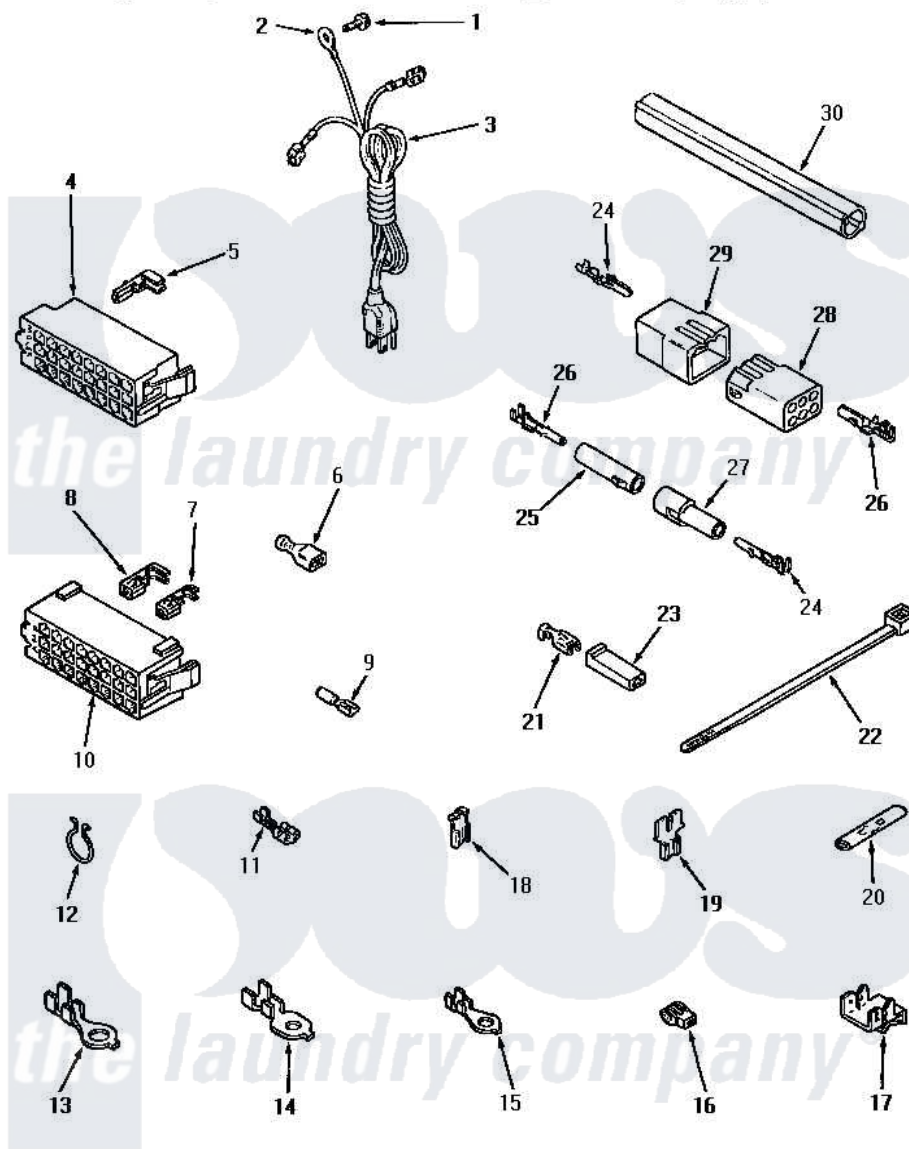

## POWER CORD AND WIRE TERMINALS

Amana [Residential Amana NA6522 Washer Parts](#) Parts Diagram 15 - POWER CORD & WIRE TERMINALS  
 Click on the part number to view part

Item	Original Part Number	Replaced By	Status	Part Description
1	<a href="#">52909</a>			Screw, 10B-16 X 1/2 HeX
2	Y00000000		Not Available	SEE NOTE GOUND WIRE -- (GREEN)
3	22660		Not Available	POWER CORD AND PLUG
4	<a href="#">34123</a>			Housing, LH -24 Position
"	<a href="#">32746</a>			Housing, RH-24 Positi
5	<a href="#">Y00188</a>			Molex Terminal
6	Y00163	<a href="#">285432</a>		Terminal
"	<a href="#">Y00165</a>			Insulated Spade Terminal
7	00180		Not Available	TERMINAL,FEMALE
8	00183		Not Available	TERMINAL,FEMALE 2-WIRE
9	<a href="#">Y00215</a>			Barrel Insulated Spade
"	Y00214		Not Available	BARREL INSULATED SPADE(18 GAUG (1/4 INCH-18 GAUGE WIRE)
10	28856		Not Available	HOUSING,24 POSITION
11	Y00119		Not Available	SPADE TERMINAL(18 GAUGE) (1/4 INCH-(1) 18

			GAUGE WIRE)
"	Y00121	Not Available	SPADE TERMINAL(12 GAUGE) (1/4 INCH-(2) 18 GAUGE WIRES O
12	<a href="#">51291</a>		Clip, Wire
13	Y00113	Not Available	TERMINAL,RING-1/4 STUD
14	<a href="#">Y00111</a>		Ring Terminal No.10 No.10 18 Gauge Wires Or
15	<a href="#">00110</a>		No.10 18 Gauge Wire
16	70210	Not Available	INSULATOR,BLUE
17	Y00161	<a href="#">B5733302</a>	Clip, Ground
18	<a href="#">Y00120</a>		Terminal, Flag-1/4 Fema
19	29673	Not Available	DOUBLE CONNECTOR
20	21091	Not Available	CONNECTOR TWO 1/4 INCH MALE
21	<a href="#">Y00115</a>		Lock In Spade Terminal (18 Gaug (1/4 Inch-(1) 18 Gauge Wire)
22	55881	<a href="#">M0321209</a>	Tie-Electrical
23	<a href="#">90789</a>		Connector
24	<a href="#">Y00116</a>		Terminal, Pin-Male
25	<a href="#">26301</a>		Receptacle, Molex
26	Y00117	<a href="#">5011-XX</a>	093 Female Socket
27	26302	Not Available	PLUG,1 CIRCUIT
28	<a href="#">26708</a>		Receptacle, 6 Circuit
29	<a href="#">23041</a>		Plug, 6 Circuit
30	33087	Not Available	ENCLOSURE,WIRE HARNESS

*the laundry company*<sup>®</sup>

*the laundry company*<sup>®</sup>