

# Amana NA6621 19 - TRANSMISSION ASSY & BALANCE RING

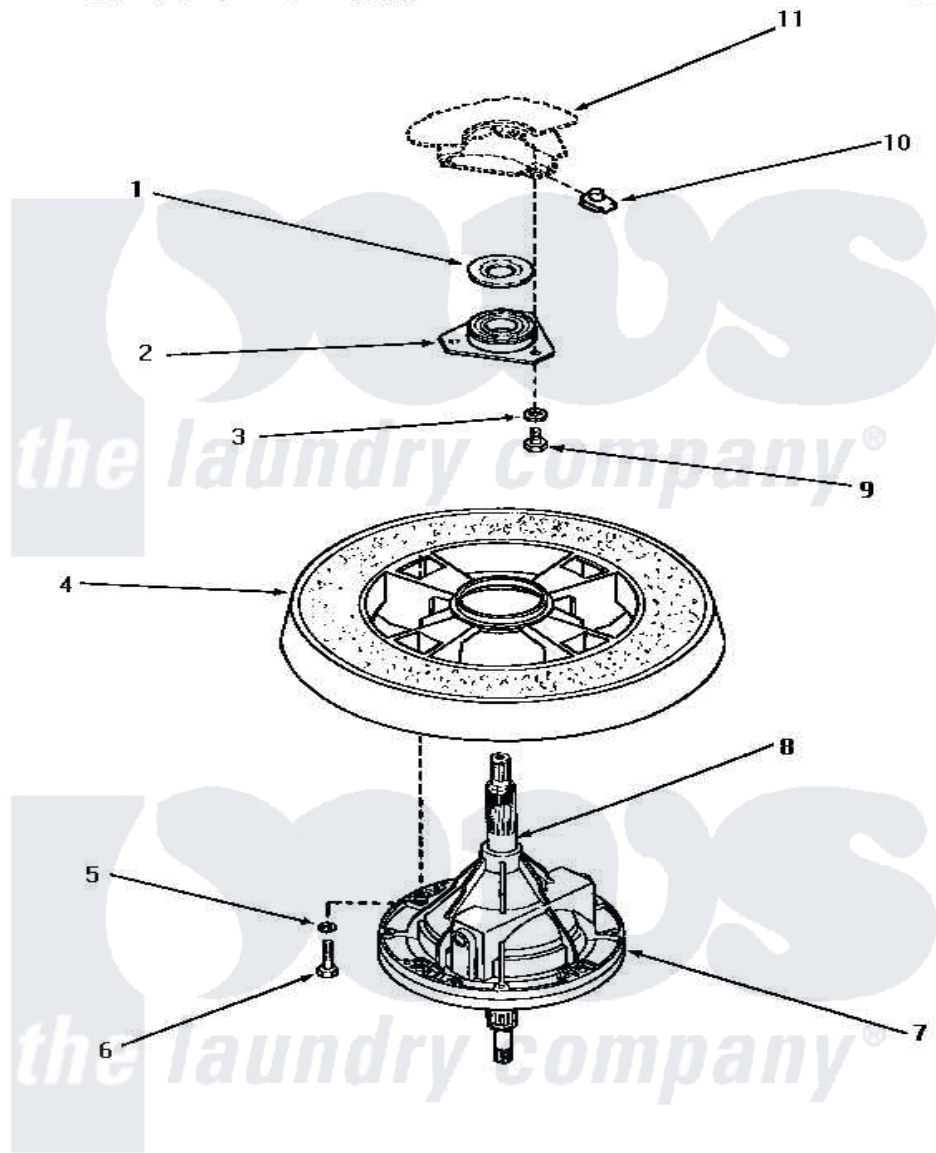

## TRANSMISSION ASSEMBLY AND BALANCE RING

Amana [Residential Amana NA6621 Washer Parts](#) Parts Diagram 19 - TRANSMISSION ASSY & BALANCE RING  
 Click on the part number to view part

| Item | Original Part Number   | Replaced By               | Status        | Part Description         |
|------|------------------------|---------------------------|---------------|--------------------------|
| 1    | <a href="#">27187</a>  |                           |               | Flinger                  |
| 2    | 27182                  | <a href="#">40004201P</a> |               | Main Bearing Assembly    |
| 3    | <a href="#">04366</a>  |                           |               | Lockwasher, 5/16intshkp  |
| 4    | Y29117                 |                           | Not Available | ASSY, BALANCE RING-COMPL |
| 5    | <a href="#">02431</a>  |                           |               | Lockwasher, 1/4 Ext Shk  |
| 6    | 27200                  |                           | Not Available | CAP SCREW                |
| 7    | 33227                  | <a href="#">33227P</a>    |               | Assembly- Tran           |
| 8    | <a href="#">27604P</a> |                           |               | Never-Seeze 1 Oz Tube    |
| 9    | 01355                  |                           | Not Available | SCREW                    |
| 10   | <a href="#">27222</a>  |                           |               | Nut, Retainer 5/16-18    |
| 11   | Y00000000              |                           | Not Available | SEE NOTE OUTER TUB       |