

# Amana NA8531 16 - PUMP ASSY/BRKT/HOSES & SIPHON BREAK KIT

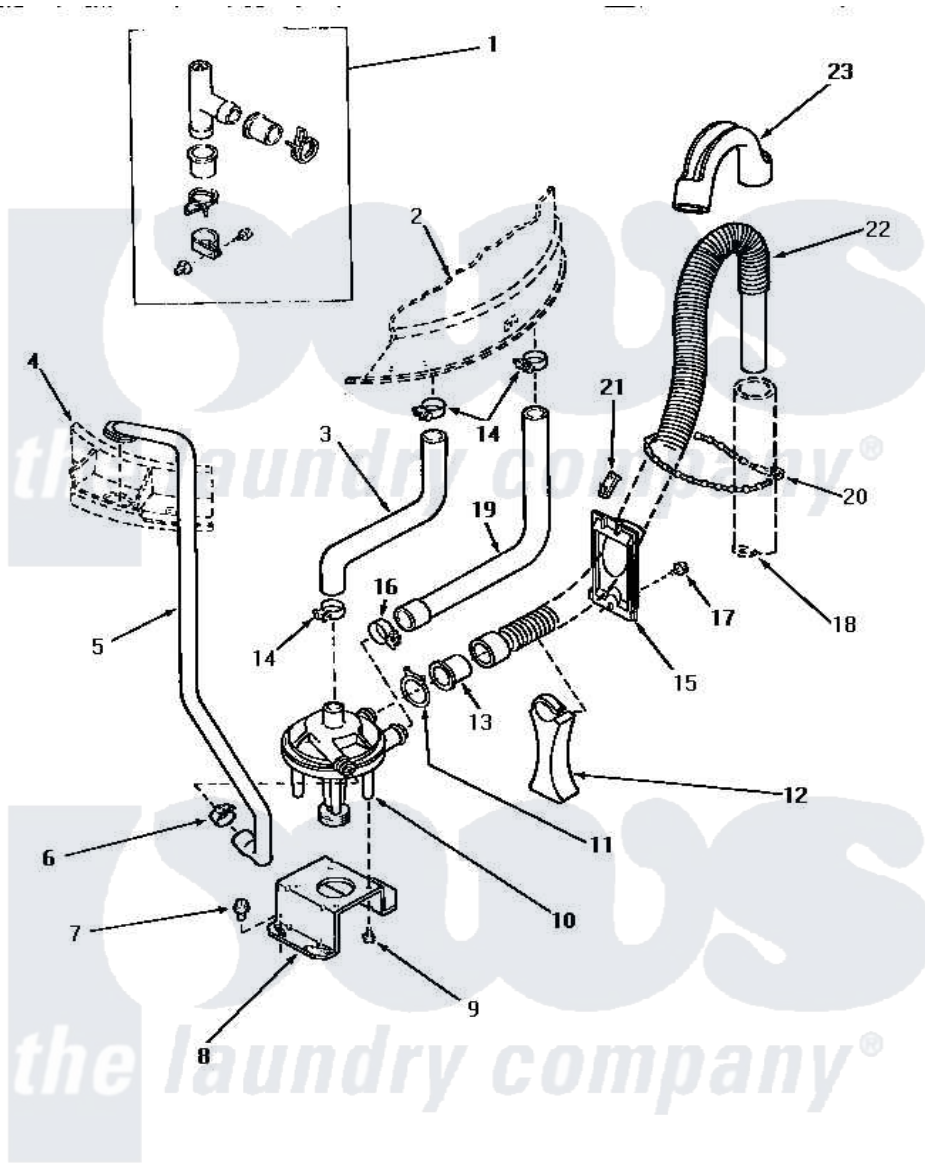

## PUMP ASSEMBLY, BRACKET, HOSES AND SIPHON BREAK KIT

Amana [Residential Amana NA8531 Washer Parts](#) Parts Diagram 16 - PUMP ASSY/BRKT/HOSES & SIPHON BREAK KIT

[Click on the part number to view part](#)

Item	Original Part Number	Replaced By	Status	Part Description
1	386P3	<a href="#">76660</a>		Break-Sphn
2	Y00000000		Not Available	SEE NOTE OUTER TUB
3	27159		Not Available	HOSE,TUB TO PUMP
4	Y00000000		Not Available	SEE NOTE OUTER TUB COVER
5	27232		Not Available	HOSE
6	27644	<a href="#">285655</a>		Clamp, Hose
7	Y31645	<a href="#">27001200</a>		Screw
8	<a href="#">27105</a>			Bracket, Pump Mounting
9	<a href="#">31098</a>			Screw, 10-10 5/8 Unslot
10	<a href="#">31968</a>			Assembly, Pump NA
"	<a href="#">31969</a>			Assembly, Pump NA
11	29172		Not Available	CLAMP,HOSE
12	<a href="#">29284</a>			Stand, Hose
13	29143		Not Available	HOSE,ADAPTER
14	32616		Not Available	(CLAMP HOSE)

15	29131		Not Available	RETAINER,DIRECTIONAL
16	27153	<a href="#">285655</a>		Clamp, Hose
17	30676	<a href="#">27001200</a>		Screw
18	Y00000000		Not Available	SEE NOTE STANDPIPE
19	27160		Not Available	HOSE,TUB TO PUMP-DRAIN
20	33489	<a href="#">8539404</a>		Tie-Wire
21	29936		Not Available	HOSE RETAINER CLIP
22	29142	<a href="#">39952</a>		Hose- Drai
23	29144	<a href="#">22003814</a>		Retainer, Drain Hose
NI	406P3	<a href="#">451P3</a>		Kit Drain Extension

