

# Amana NA8631 04 - BRG HSG/BRAKE/PULLEY & PIVOT DOME

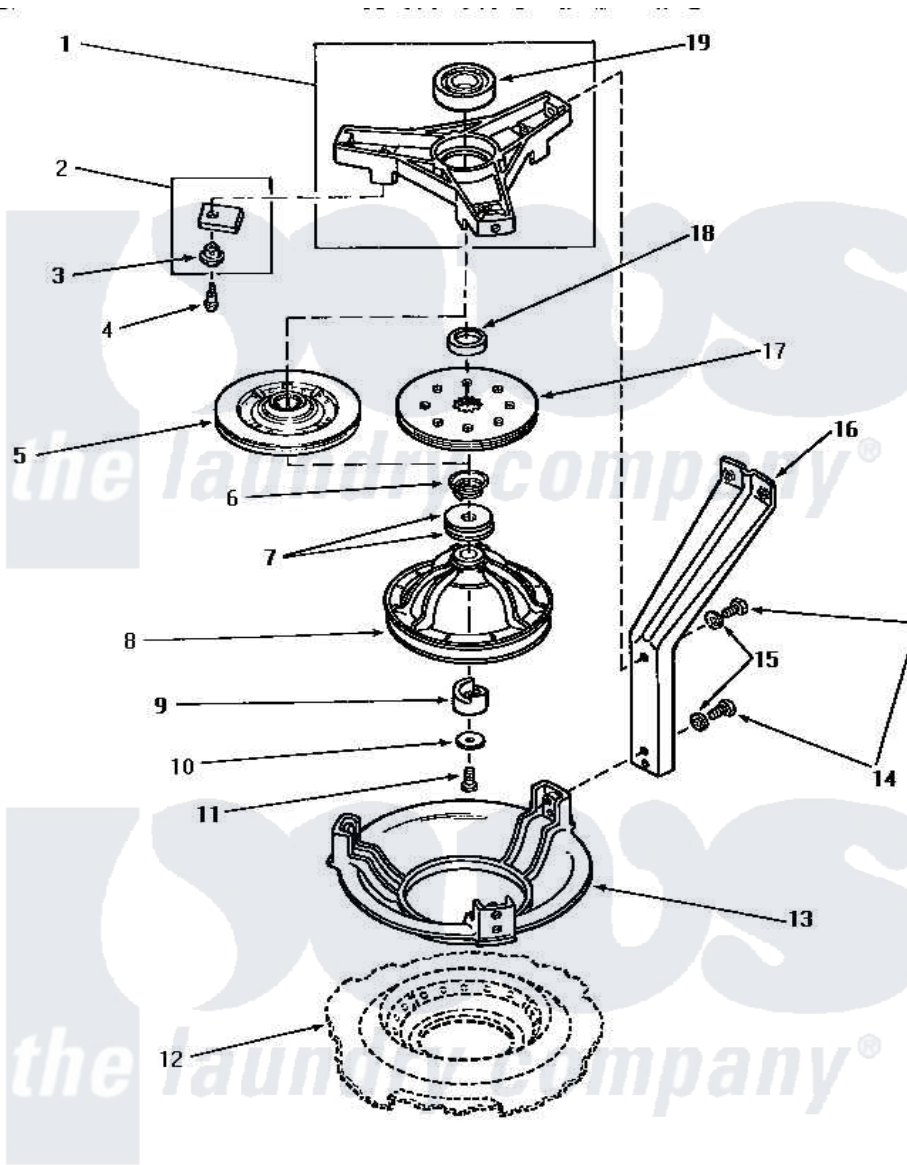

## BEARING HOUSING, BRAKE, PULLEY AND PIVOT DOME

Amana [Residential Amana NA8631 Washer Parts](#) Parts Diagram 04 - BRG HSG/BRAKE/PULLEY & PIVOT DOME  
 Click on the part number to view part

Item	Original Part Number	Replaced By	Status	Part Description
1	28913	<a href="#">35746</a>		AssemLy, Bearing Housing-L
2	348P3	<a href="#">R9900543</a>		Pad-Brake
3	<a href="#">29993</a>			Sleeve, Anti-Rotation
4	<a href="#">26547</a>			Screw, 10-24 Shoulder
5	31961P	<a href="#">R9900474</a>		Brake Assembly
6	<a href="#">33435</a>			Spring, Conical
7	32651	<a href="#">40065701</a>		Washer, 2 Odx.63 ID
8	30260	<a href="#">34232P</a>		Kit-Pulley
9	<a href="#">27018</a>			Helix
10	26509	<a href="#">40041501</a>		Washer
11	27220	<a href="#">40063401</a>		Screw, 1/4-20 x 5/8 Hex
12	Y00000000		Not Available	SEE NOTE BASE ASSEMBLY
13	27124		Not Available	DOME,PIVOT
14	30016	<a href="#">40128701</a>		Screw, 5/16-18 X .50
15	<a href="#">04366</a>			Lockwasher, 5/16intshkp
16	<a href="#">27090</a>			Leg, Support

17 26556P

[R9900474](#)

Brake Assembly

18 [27176](#)

Spacer

19 28944

[40004001](#)

Bearing, Main

