

Amana NA8831 22 - WIRE TERMINALS

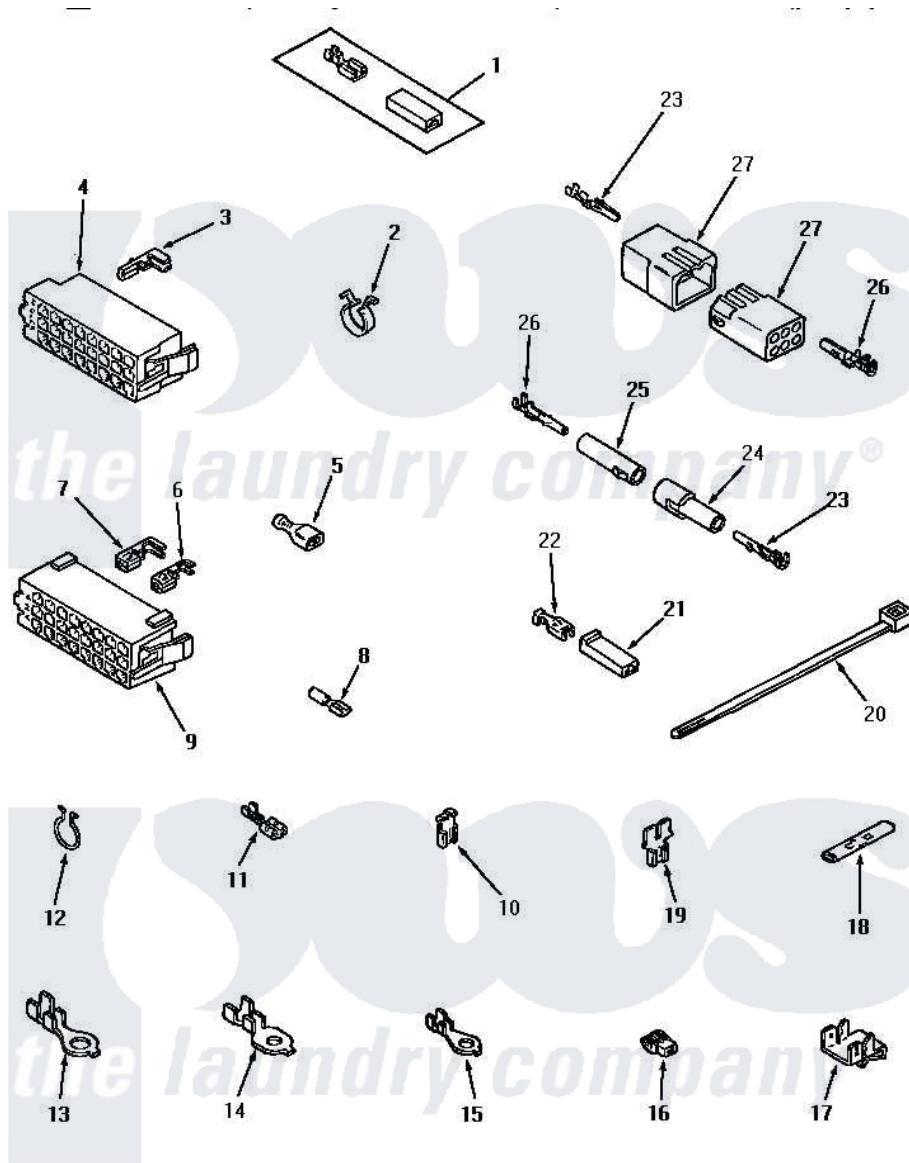

WIRE TERMINALS

[Amana Residential Amana NA8831 Washer Parts](#) Parts Diagram 22 - WIRE TERMINALS

[Click on the part number to view part](#)

Item	Original Part Number	Replaced By	Status	Part Description
1	00234	00359		Terminal Ultra Pod 250 X032F
2	61510	504034		Clip, Wire
3	Y00188			Molex Terminal
4	34123			Housing, LH -24 Position
"	32746			Housing, RH-24 Positi
5	Y00163	285432		Terminal
"	Y00165			Insulated Spade Terminal
6	00180		Not Available	TERMINAL,FEMALE
7	00183		Not Available	TERMINAL,FEMALE 2-WIRE
8	Y00215			Barrel Insulated Spade
"	Y00214		Not Available	BARREL INSULATED SPADE(18 GAUG (1/4 INCH-18 GAUGE WIRE)
9	28856		Not Available	HOUSING,24 POSITION
10	Y00120			Terminal, Flag-1/4 Fema
11	Y00119		Not Available	SPADE TERMINAL(18 GAUGE) (1/4 INCH-(1) 18 GAUGE WIRE)

"	Y00121	Not Available	SPADE TERMINAL(12 GAUGE) (1/4 INCH-(2) 18 GAUGE WIRES O
12	51291		Clip, Wire
13	Y00113	Not Available	TERMINAL,RING-1/4 STUD
14	Y00111		Ring Terminal No.10 No.10 18 Gauge Wires Or
15	00110		No.10 18 Gauge Wire
16	70210	Not Available	INSULATOR,BLUE
17	Y00161	B5733302	Clip, Ground
18	21091	Not Available	CONNECTOR TWO 1/4 INCH MALE
19	29673	Not Available	DOUBLE CONNECTOR
20	55881	M0321209	Tie-Electrical
21	90789		Connector
22	Y00115		Lock In Spade Terminal (18 Gaug (1/4 Inch-(1) 18 Gauge Wire)
23	Y00116		Terminal, Pin-Male
24	26302	Not Available	PLUG,1 CIRCUIT
25	26301		Receptacle, Molex
26	Y00117	5011-XX	093 Female Socket
27	26708		Receptacle, 6 Circuit
28	23041		Plug, 6 Circuit

