

Amana NG5319 08 - LOADING DOOR, FRONT PANELS & ACCESS DOOR

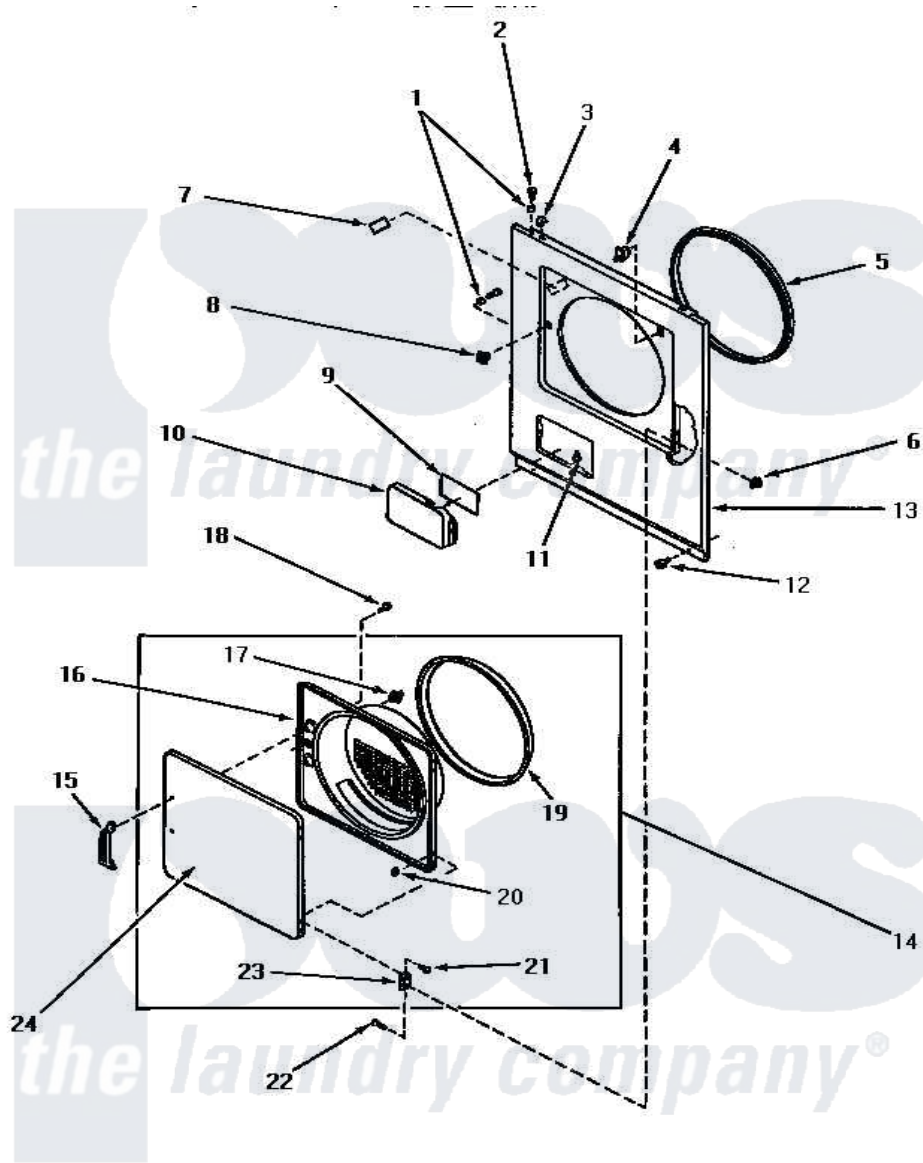

LOADING DOOR, FRONT PANELS AND ACCESS DOOR

Amana [Residential Amana NG5319 Washer Parts](#) Parts Diagram 08 - LOADING DOOR, FRONT PANELS & ACCESS DOOR

[Click on the part number to view part](#)

Item	Original Part Number	Replaced By	Status	Part Description
1	56079	505187		Locator, Panel
2	32671	Y014874		Screw, Idler Arm And Sleeve
3	28835	22001650		Fastener, Spring
4	57012	W10169313		Switch-Dor
5	Y61380			Seal, Front Panel
6	51236	488130		Nut
7	58854			Repl By 500281
8	54660	LA-1003		Door Catch Kit
9	56427		Not Available	STICKER
10	60795L		Not Available	DOOR,ACCESS
"	60795W			Door, Access
"	60795H		Not Available	DOOR,ACCESS
11	56534			Barrel, Support
12	58637	27001200		Screw
13	62421W		Not Available	PANEL, FRONT
"	62421L		Not Available	PANEL, FRONT

"	62421H		Not Available	PANEL,FRONT-GAS
14	62151H		Not Available	ASSY,DOOR
"	62151L		Not Available	ASSY,DOOR
"	62151W		Not Available	ASSY,DOOR
15	54068P	61925		Pull Door Commercial Black
16	62152L	62152P		Liner
"	62152H		Not Available	INNER DOOR PANEL, HARVEST GOLD
"	62152W		Not Available	LINER,DOOR
17	54661	LA-1003		Door Catch Kit
18	Y33561	489464		Screw
19	61379	61379P		Door Seal
20	23407			Nut, Speed-8A Tinn C15
21	52864	500226		Screw, 8b-16 x 5/8 Tap
22	22649			Screw, 8-32 X 13/32 FI
23	56045			Hinge
24	62153L		Not Available	DOOR
"	62153W		Not Available	PANEL OUTER DOOR
"	62153H			Door

