

# Magic Chef W226LV 01 - BASE

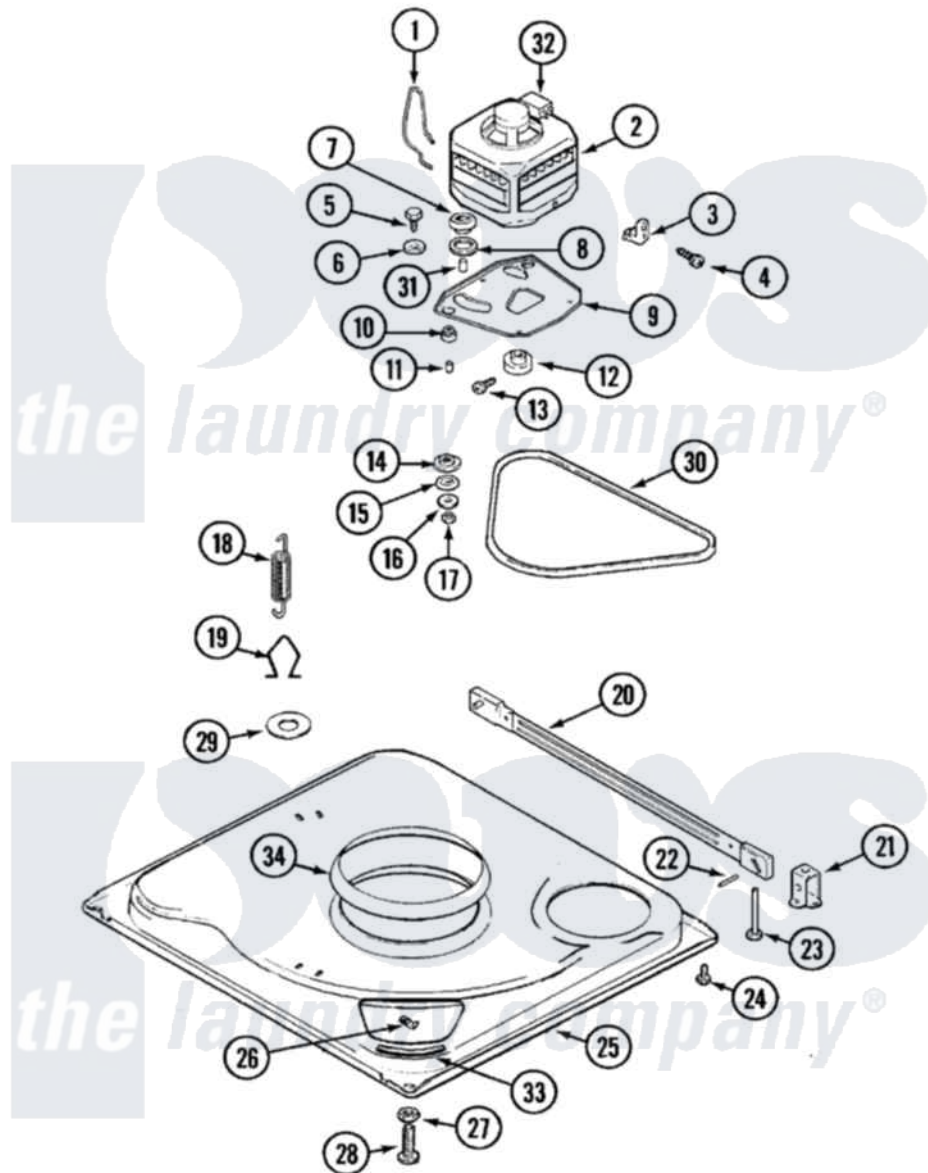

Magic Chef [Residential Magic Chef W226LV Washer Parts](#) Parts Diagram 01 - BASE  
 Click on the part number to view part

Item	Original Part Number	Replaced By	Status	Part Description
1	21001110	<a href="#">22004376</a>		Spring, Motor Pivot
2	<a href="#">21001170</a>			Motor And Pulley/Plate Assembly
"	<a href="#">21001400</a>			Motor/Plate Assembly
3	21001109	<a href="#">21001486</a>		Foot Slide, Isolator
4	25-7418	<a href="#">33001178</a>		Back, Tumbler
5	25-7833	<a href="#">21001977</a>		Screw
6	<a href="#">25-7834</a>			Washer, Motor/Base Screw
7	<a href="#">33-9946</a>			Isolator, Motor
8	<a href="#">35-3570</a>			Washer, Motor Pivot
9	21001111	<a href="#">21001783</a>		Plate And Screw Assembly
10	<a href="#">35-3646</a>			Isolator, Motor Plate
11	<a href="#">25-7831</a>			Spacer, Mounting
12	<a href="#">21001108</a>			Pulley, Motor
13	<a href="#">25-7117</a>			Set Screw
14	<a href="#">35-3571</a>			Slide, Motor Pivot
15	<a href="#">33-9967</a>			Washer, Motor Isolator

16	<a href="#">25-7047</a>		Washer, Flat
17	25-7325	<a href="#">Y707702</a>	Locknut
18	21001138	<a href="#">22002922</a>	Tool, Spring Removal
"	<a href="#">21001165</a>		Spring, Suspension
19	<a href="#">21001166</a>		Hook, Suspension Spring
20	35-2049	<a href="#">21001881</a>	Bar, Stabilizer
21	<a href="#">35-2046</a>		Bracket, Stabilizer
22	<a href="#">35-2052</a>		Pin, Stabilizer
23	35-3020	<a href="#">22004469</a>	Leg And Foot Self Stabalizing
24	25-7828	<a href="#">489483</a>	Screw 10-32 X 1/2
25	21001169	<a href="#">12002701</a>	Base Kit
26	<a href="#">25-7845</a>		Speednut, Motor
27	<a href="#">25-7915</a>		Hex Nut
28	35-0837	<a href="#">25001119</a>	Foot And Pad Assembly
"	35-3507	<a href="#">25001119</a>	Foot And Pad Assembly
29	<a href="#">Y25-7951</a>		Washer, Suspension Hook
30	<a href="#">21352320</a>		Belt, Drive
31	<a href="#">25-7830</a>		Spacer
32	<a href="#">33-9765</a>		Switch, Motor
33	<a href="#">35-2065</a>		Pad, Motor Plate
34	21001161	<a href="#">21002026</a>	Snubber

