

Maytag A17CM 10 - 'POLY' PUMP

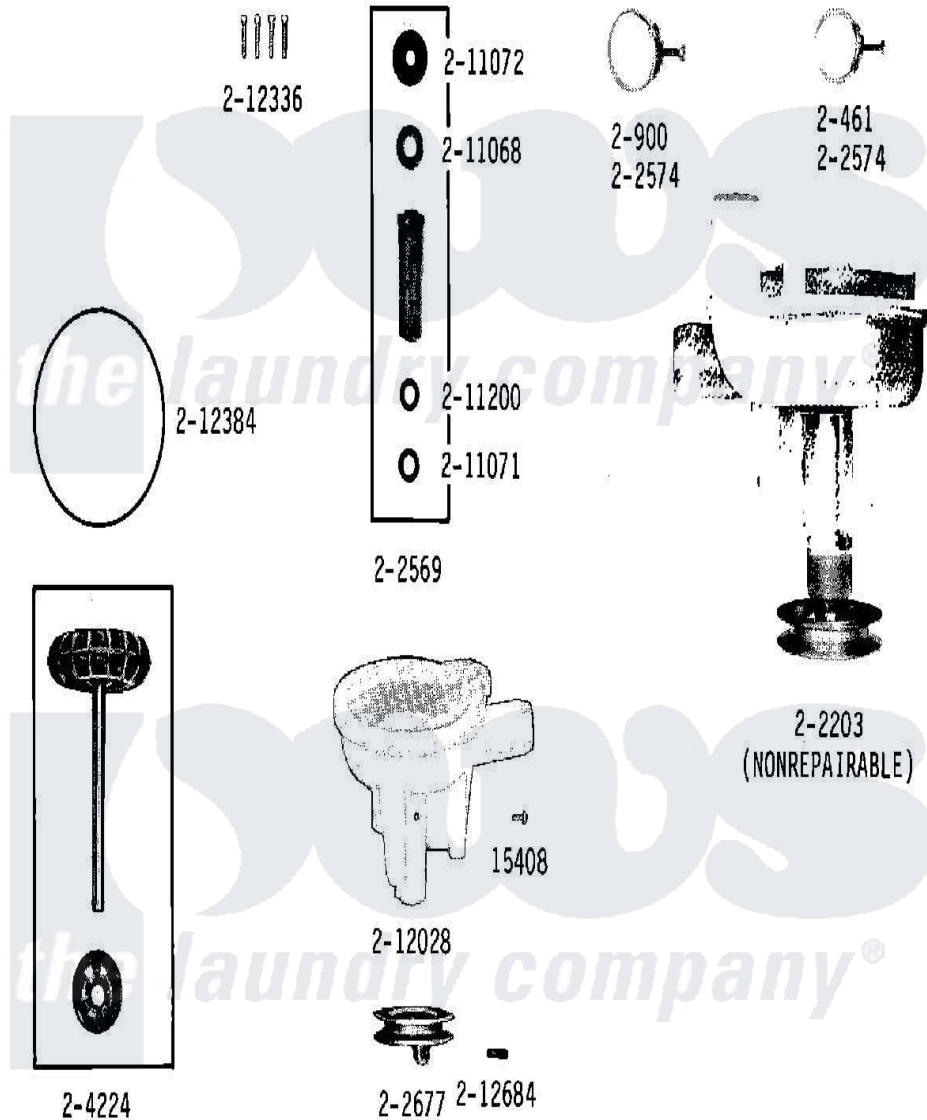

Maytag [Residential Maytag A17CM Washer Parts](#) Parts Diagram 10 - 'POLY' PUMP
 Click on the part number to view part

Item	Original Part Number	Replaced By	Status	Part Description
001	Y015408	22003235		Screw, Bearing Insert
002	200461	285655		Clamp, Hose
003	200900	616099		Clamp
004	202203	6-2022030		Pump As Pa
005	NLA		Not Available	PUMP BEARING KIT
006	202574	3367052		Clamp, Hose
007	NLA		Not Available	PUMP PULLEY WITH PIN
008	204224			Impeller And Seal Assembly
009	211068			Wicking-Top
010	NLA		Not Available	OIL SLINGER-BOTTOM
011	211072			Oil And Water Slinger-Top
012	211200			WASHER
013	NLA		Not Available	PUMP HOUSING, POLY
014	NLA		Not Available	SCREW, No.8 X 3/4 INCH
015	212384			Gasket For Poly Pump
016	212684			Rollpin For Pump Pulley