

Maytag A284 02 - CABINET, WATER VALVE, HOSES & FRNT PANEL

MODELS A105-A283-A284

CABINET, WATER VALVE, HOSES & FRONT PANEL

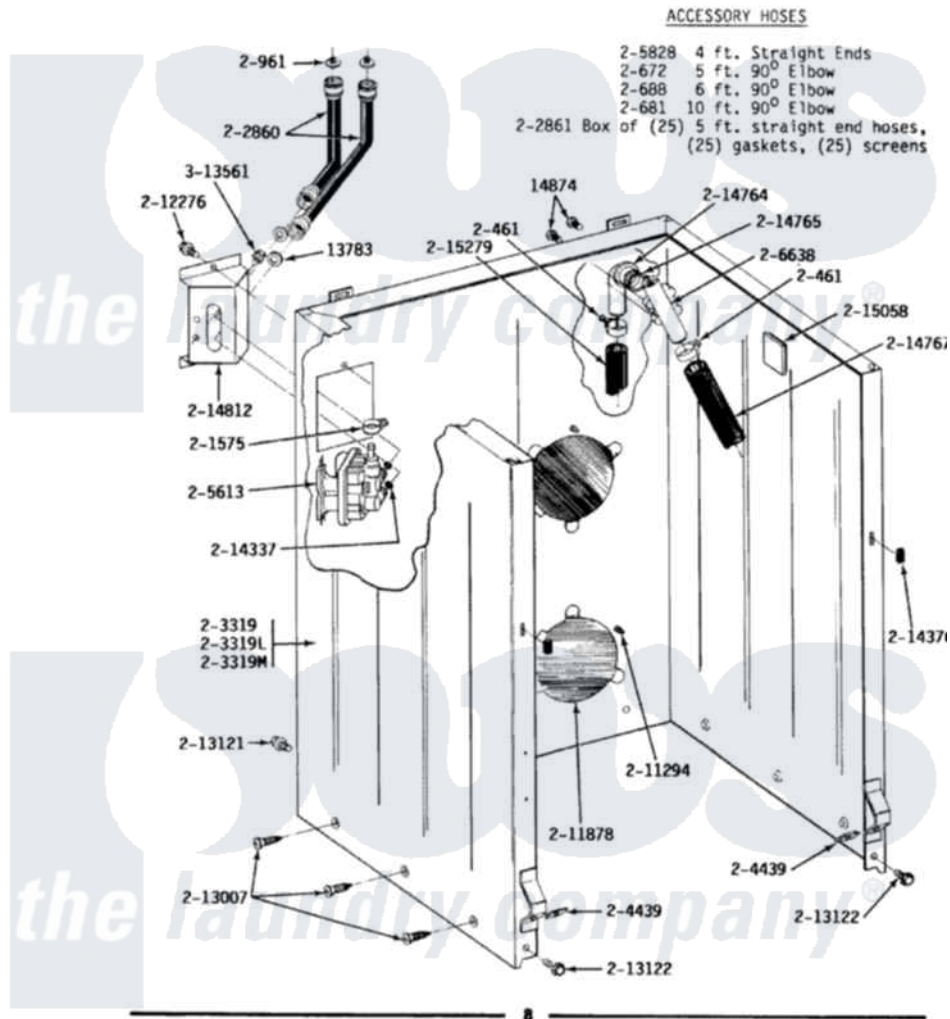

Maytag Residential Maytag A284 Washer Parts Diagram 02 - CABINET, WATER VALVE, HOSES & FRNT PANEL

Click on the part number to view part

Item	Original Part Number	Replaced By	Status	Part Description
1	Y013783			Washer, Inlet Hose
2	Y014874			Screw, Idler Arm And Sleeve
3	200461	285655		Clamp, Hose
4	200672	76314		Hose, Inlet 6 Ft. Hose With Elbow
5	200681	21001467		Hose- 10'
6	200688	76314		Hose, Inlet 6 Ft. Hose With Elbow
NI	Y200832			Capacitor
8	200961	12001413		Strainer And Washer Kit
9	201575			Clamp, Hose
10	202860			Inlet Hose Assembly
11	202861	202860		Inlet Hose Assembly
NI	203237			No.17 Wire With Terminal
13	203319	22203319		Cabinet
16	204439			Screw And Fstner Assembly

17	205613		Water Valve
18	205828	202860	Inlet Hose Assembly
NI	206103		Capacitor Kit
20	206638		Siphon Break
NI	211149		Clip, Capacitor
22	211294	90767	Screw, 8A X 3/8 HeX Washer Head Tapping
23	211878	Not Available	PLATE, ACCESS
24	212276	W10116760	Screw
NI	212982	22001650	Fastener, Spring
"	212998	Not Available	PANEL, FRONT (WHT)
29	213007		Xfor Cabinet See Cabinet, Back
30	213121	3400111	Screw, 12-14 X 5/8
31	213122	27001200	Screw
NI	213846		Guard, Belt
33	214337	96160	Screen
34	214376	22002331	Spacer, Front Panel
35	214764	208847	Elbow
36	214765		Gasket, Siphon Break
37	214767	22001448	Hose, Pump
38	214812	22002361	Bracket, Water Valve
39	215058		Pad, Cabinet Bumper
40	215279	22003410	Hose, Drain
41	Y313561		Screw---NA

the laundry company[®]

the laundry company[®]