

Maytag A8240 06 - TOP COVER, CONSOLE & LID SWITCH

SECTION: TOP COVER, CONSOLE & LID SWITCH
 MODEL: ALL MODELS

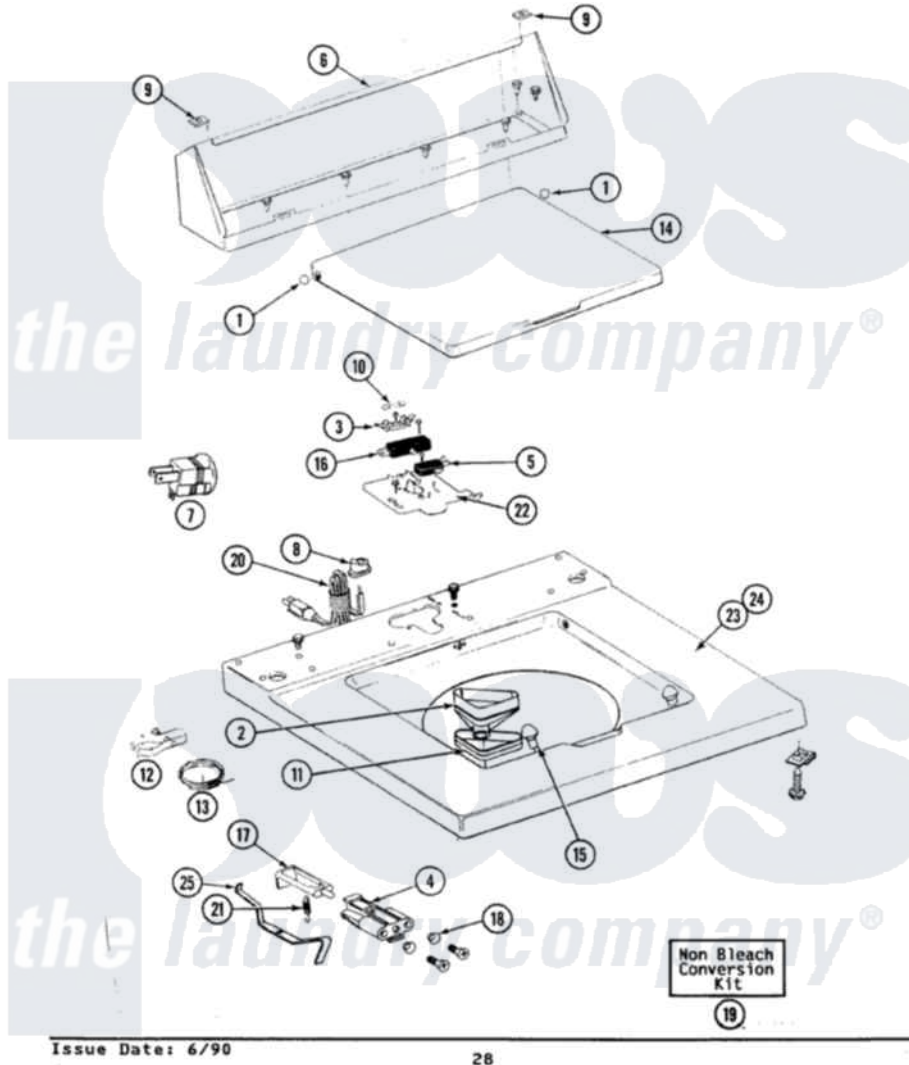

Issue Date: 6/90

28

[Maytag Residential Maytag A8240 Washer Parts](#) Parts Diagram 06 - TOP COVER, CONSOLE & LID SWITCH
 Click on the part number to view part

Item	Original Part Number	Replaced By	Status	Part Description
1	211726			Hinge, Ball Lid
2	215577			Bleach Inlet White
3	215705	Y311711		Screw, Fuse Block
"	207167			Block, Fuse
4	216256		Not Available	BRACKET, UNBALANCE
"	910182	25-7809		Screw, No.6-20 1/2 Flthd Torx
"	214279	204968		Plunger And Bracket Assembly--W
5	912012	3400409		Screw
"	207166			Switch, Check
6	205635			Console
"	211294	90767		Screw, 8A X 3/8 HeX Washer Head Tapping
"	Y313559			Screw
7	Y201808			Converter
8	211881			Grommet, Cord Part Not Used-Gas Models Only

9	215075		Fastener, Control Panel To Console
10	207168	22001682	Switch Assembly, Lid W/4amp Fuse
11	214436		Gasket
12	301548		Clamp, Ground Wire
13	311155		Ground Wire And Clamp
14	212073		LID (WHITE)
15	212716		Bumper, Lid
16	213501		Screw, No.6-20 X 1-1/8 Inch
"	205415	279347	Switch-Lid
17	215700	Not Available	LID SWITCH PLUNGER
"	208591	Not Available	KIT, PLUNGER & BRACKET
18	211500		Washer, Bracket To Top Cover
19	205997		Non-Bleach Conversion Kit
20	204590		Cord, Power
"	210186	3370225	Screw
21	213720		Spring, Lid Switch
22	Y215699	22001678	Bracket, Switch And Fuse
"	207159	489355	Screw, 8 X 1/2
23	207170		Top Cover
24	204445		Screw And Fastener Assembly
"	210186	3370225	Screw
"	207172		Top Cover
25	215704		Lever, Unbalance

