

# Maytag A9200 03 - CLUTCH, BRAKE & BELTS

SECTION: CLUTCH, BRAKE & BELTS  
 MODEL: ALL MODELS

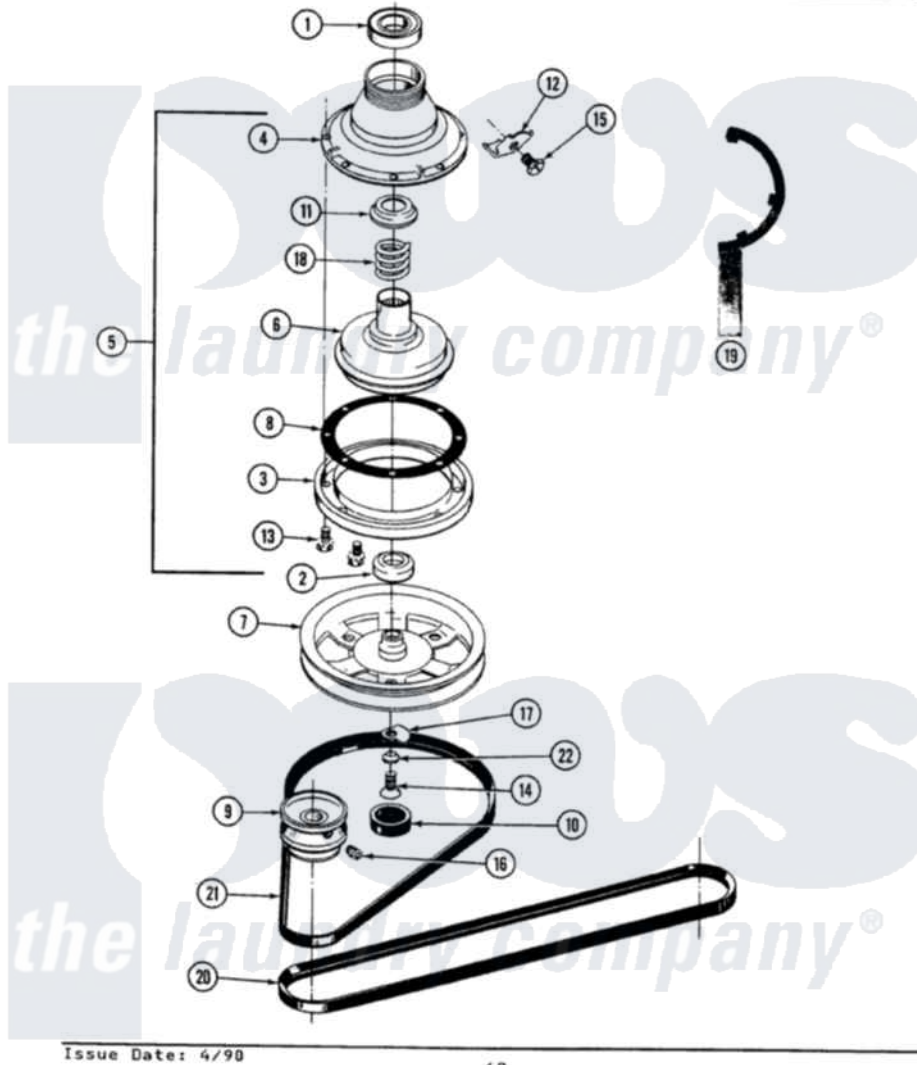

Issue Date: 4/90

48

Maytag Residential Maytag A9200 Washer Parts Parts Diagram 03 - CLUTCH, BRAKE & BELTS  
 Click on the part number to view part

Item	Original Part Number	Replaced By	Status	Part Description
1	Y200720	<a href="#">22003441</a>		Bearing, Rear
2	<a href="#">200835</a>			Bearing, Brake Rotor
3	211043	<a href="#">6-2011900</a>		Brake Asse
4	211045	<a href="#">6-2011900</a>		Brake Asse
5	201190	<a href="#">6-2011900</a>		Brake Asse
6	201126	<a href="#">6-2011900</a>		Brake Asse
7	211059	<a href="#">6-2301530</a>		Pulley
8	211042	<a href="#">6-2011900</a>		Brake Asse
9	200816	<a href="#">6-2008160</a>		Pulley- MO
10	211038		Not Available	CAP, OIL RETAINER
11	211039	<a href="#">6-2011900</a>		Brake Asse
12	<a href="#">213325</a>			Clip, Retaining
13	211000			SCREW, BRAKE DRUM (HEX HEAD)
14	211375	<a href="#">681582</a>		Screw
15	<a href="#">213326</a>			Bolt, Sems Retaining Clip
16	<a href="#">Y053241</a>			Set Screw, Motor Pulley

17	<a href="#">211089</a>		Lug, Stop Pulley
18	211041	<a href="#">6-2011900</a>	Brake Asse
19	Y038315	<a href="#">038315</a>	Tool
20	<a href="#">211124</a>		Part Not Used
21	<a href="#">211125</a>		V Belt, Drive Pulley
22	211090	<a href="#">22003555</a>	Washer, Stop Lug

