

# Maytag A9700 07 - TOP COVER, CONSOLE & LID SWITCH

SECTION: TOP COVER, CONSOLE & LID SWITCH  
 MODEL: ALL MODELS

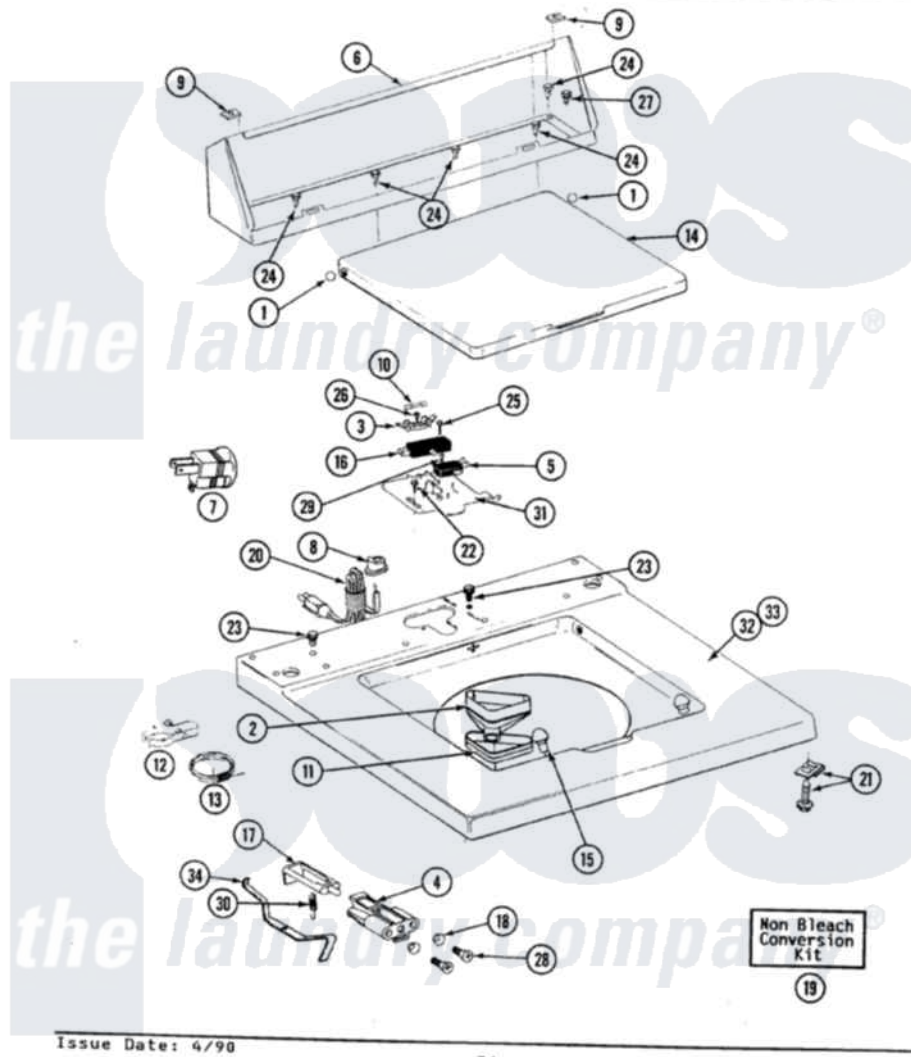

Issue Date: 4/98

34

Maytag Residential Maytag A9700 Washer Parts Parts Diagram 07 - TOP COVER, CONSOLE & LID SWITCH  
 Click on the part number to view part

Item	Original Part Number	Replaced By	Status	Part Description
1	<a href="#">211726</a>			Hinge, Ball Lid
2	<a href="#">215577</a>			Bleach Inlet White
3	<a href="#">207167</a>			Block, Fuse
4	216256		Not Available	BRACKET, UNBALANCE
"	214279	<a href="#">204968</a>		Plunger And Bracket Assembly--W
5	<a href="#">207166</a>			Switch, Check
6	<a href="#">205635</a>			Console
7	<a href="#">Y201808</a>			Converter
8	<a href="#">211881</a>			Grommet, Cord Part Not Used-Gas Models Only
9	<a href="#">215075</a>			Fastener, Control Panel To Console
10	207168	<a href="#">22001682</a>		Switch Assembly, Lid W/4amp Fuse
11	<a href="#">214436</a>			Gasket
12	<a href="#">301548</a>			Clamp, Ground Wire
13	<a href="#">311155</a>			Ground Wire And Clamp

14	212073		LID (WHITE)
15	<a href="#">212716</a>		Bumper, Lid
16	205415	<a href="#">279347</a>	Switch-Lid
17	208591		Not Available KIT, PLUNGER & BRACKET
"	215700		Not Available LID SWITCH PLUNGER
18	<a href="#">211500</a>		Washer, Bracket To Top Cover
19	<a href="#">205997</a>		Non-Bleach Conversion Kit
20	<a href="#">204590</a>		Cord, Power
21	<a href="#">204445</a>		Screw And Fastener Assembly
22	207159	<a href="#">489355</a>	Screw, 8 X 1/2
23	210186	<a href="#">3370225</a>	Screw
24	211294	<a href="#">90767</a>	Screw, 8A X 3/8 HeX Washer Head Tapping
25	<a href="#">213501</a>		Screw, No.6-20 X 1-1/8 Inch
26	215705	<a href="#">Y311711</a>	Screw, Fuse Block
27	<a href="#">Y313559</a>		Screw
28	910182	<a href="#">25-7809</a>	Screw, No.6-20 1/2 Flthd Torx
29	912012	<a href="#">3400409</a>	Screw
30	<a href="#">213720</a>		Spring, Lid Switch
31	Y215699	<a href="#">22001678</a>	Bracket, Switch And Fuse
32	<a href="#">207170</a>		Top Cover
34	<a href="#">215704</a>		Lever, Unbalance

