

Maytag DG309 05 - INLET DUCT, GAS VALVE, CONE & EXT. (01)

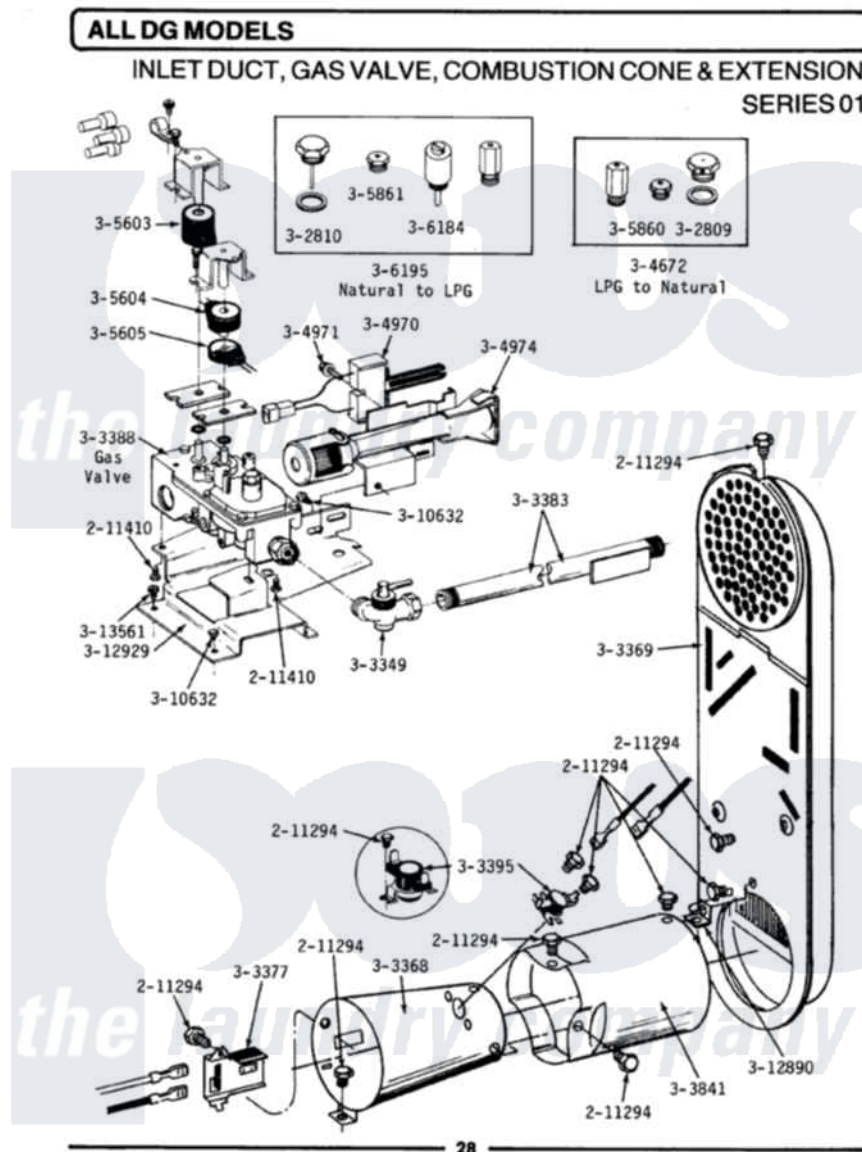

Maytag Residential Maytag DG309 Dryer Parts Parts Diagram 05 - INLET DUCT, GAS VALVE, CONE & EXT. (01)
 Click on the part number to view part

Item	Original Part Number	Replaced By	Status	Part Description
1	211294	90767		Screw, 8A X 3/8 HeX Washer Head Tapping
2	211410			Screw, HeX Head No.8 X 3/8 Inch
3	302809			Screw Assembly - Leak Limit
4	302810			Screw Assembly - Blue Block Ope
5	Y303349			Angle Shut-Off, Gas Valve
6	Y303368			Cone, Combustion
7	Y303369			Inlet Duct Assembly
8	Y303377	338906		Radiant, Sensor
9	Y303383	33001735		Pipe And Bracket Assembly Series 18 Not Needed Use Vavle
10	W10116794			Gas Valve
11	303395			Thermostat, Hi-Limit
12	Y303841			Cone, Extension
13	Y304672			Conversion Kit-LPG To Nat.

14	304970	4391996	Ignitor
15	304971		Screw Note: Screw, Igniter
16	304974	33002793	Burner Assembly
17	305603		Secondary Coil
18	305604		Holding Coil
19	305605		Booster Coil
20	305860		Not Available MAIN BURNER ORIFICE KIT-NAT
21	305861		Not Available MAIN BURNER ORIFICE KIT-LPG
22	305862		Not Available MAIN BURNER ORIFICE KIT-MIX
23	305863	0305863	Harness Ignition WI
24	306184		Not Available PLUG, BLOCKING (LPG REGULATOR)
25	Y306195	MAL9000AXX	LP Gas Con
26	Y310632	1163839	Screw
27	Y312890		Retainer, Heater Chamber
28	312929		Gas Valve Bracket
29	Y313561		Screw---NA

