

Maytag GA9900 07 - TUB, AGITATOR, MOUNTING STEM & SEAL

SECTION: TUB AGITATOR, MOUNTING STEM & SEAL
 MODEL: ALL MODELS

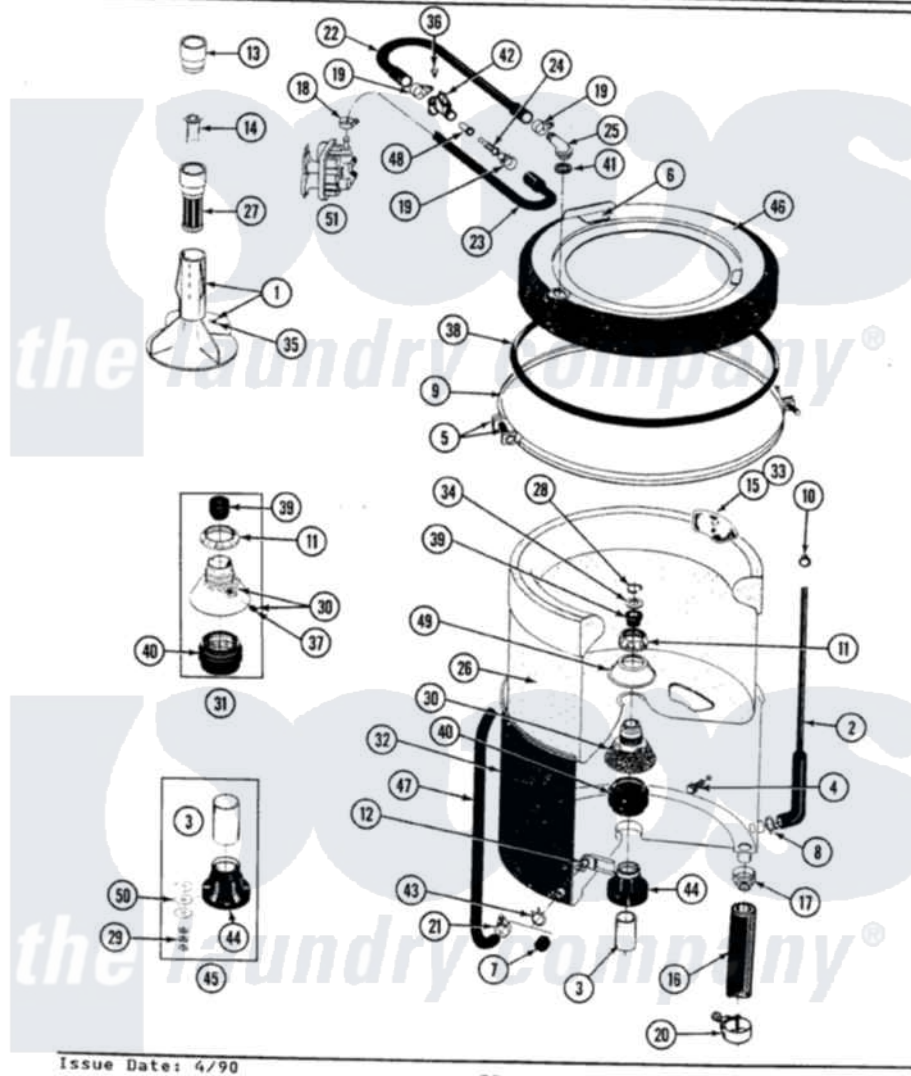

Issue Date: 4/90

38

Maytag Residential Maytag GA9900 Washer Parts Parts Diagram 07 - TUB, AGITATOR, MOUNTING STEM & SEAL
 Click on the part number to view part

Item	Original Part Number	Replaced By	Status	Part Description
1	207228			Agitator W/Lock Screw
2	215976			Air Tube
"	212942	22001619		Tube, Water Level Switch
3	211130			Bearing Liner, Tub Bearing
4	200744	W10175939		Bolt
"	205254	W10175938		Bolt
5	205529			Nut And Bolt Kit For Tub Clam
6	215232			Bumper, Unbalance
7	214725			Cap For Spout-Outer Tub
8	211641			Clamp, 1-1/16"
9	200846			Clamp - Tub Cover
10	410296	596669		Clamp, Manifold
11	211047	6-2110472		Nut- Clamp
12	214434			Spout, Deflector
13	215721			Dispensing Cap
14	215733			Dispensing Cup

15	207219		Filter, Self-Cleaning
16	213045		Hose, Outer Tub Part Not Used
17	200900	616099	Clamp
18	201575		Clamp, Hose
19	202515	596669	Clamp, Manifold
20	202574	3367052	Clamp, Hose
21	205161	489503	Clamp
22	Y215234		Hose, Injector Fill
23	213013		Hose, Injector
24	213015		Nozzle, Injector
25	215235		Tube, Injector
26	207831	Not Available	TUB, INNER (W/PLUG)
27	207657		Lint Filter Deep
"	207426		Lint Filter Deep
28	Y015667		Retaining Ring
29	Y054867		Washer, Lock
30	202521	6-2095720	Mounting S
31	204012	6-2095720	Mounting S
32	205484		Tub, Outer Part Not Used
33	215980		Plug, Filter Hole
34	Y015666		Washer, Retaining -
35	206478	Not Available	SCREW & WASHER FOR AGITATOR
36	312620		Screw, Sems
37	211618	22001423	Set Screw, Mounting Stem
38	211232		Seal, Tub Cover
39	Y0A4298	6-0A57420	Seal- Agitator
40	201537	6-2095720	Mounting S
41	215233		Seal For Injector Tube
42	215447		Sleeve For Injector
43	214739	596669	Clamp, Manifold
44	200824	6-2040130	Tub Bearin
45	204013	6-2040130	Tub Bearin
46	206380	Not Available	COVER, TUB
47	214433		Tube, Inlet Part Not Used
48	213016	216201	Nozzle
49	211210		Washer, Clamping Nut
50	211100		Washer, Outer Tub
51	205613		Water Valve

the laundry company[®]