

# Maytag LAT8240AAW 01 - BASE

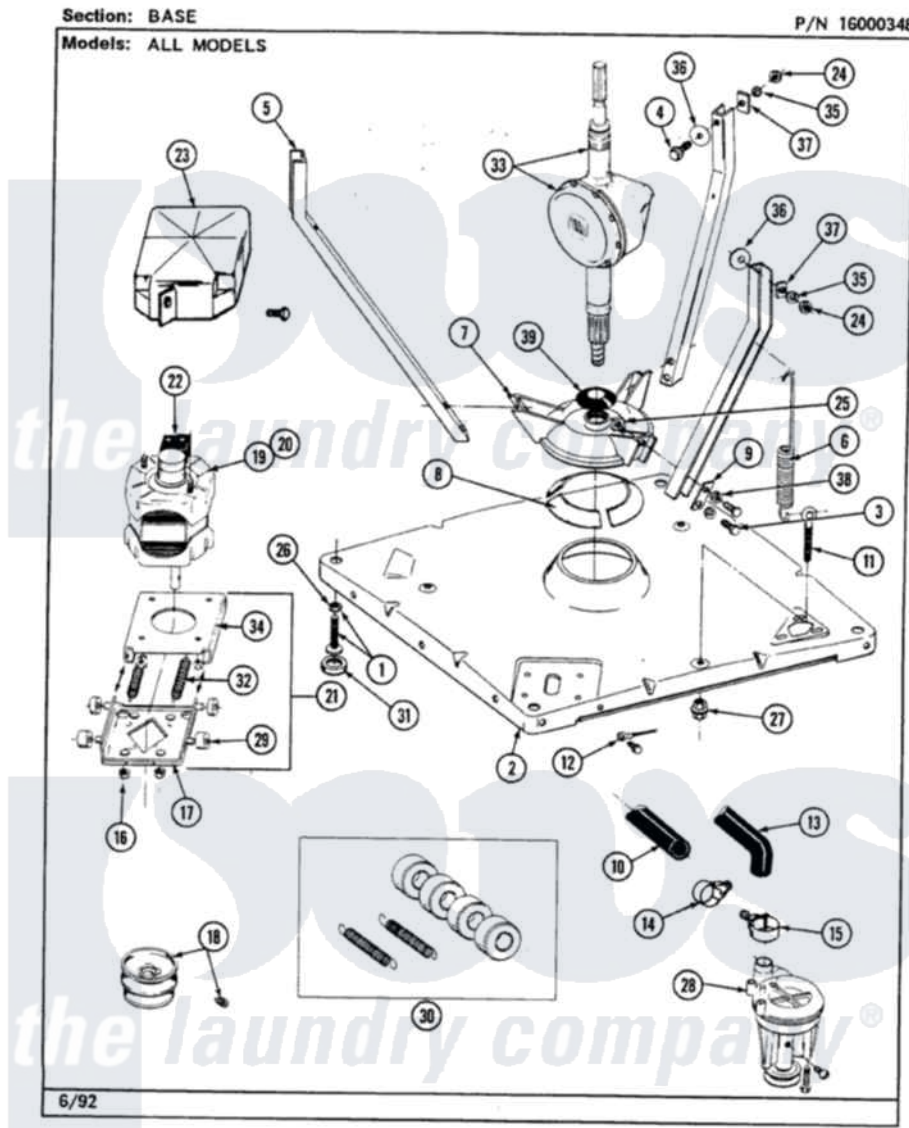

38

Maytag [Residential Maytag LAT8240AAW Washer Parts](#) Parts Diagram 01 - BASE  
 Click on the part number to view part

Item	Original Part Number	Replaced By	Status	Part Description
1	Y302699	<a href="#">22003428</a>		Leg, Adjustable
2	<a href="#">203274</a>			Base With Damper Pads
3	<a href="#">Y015627</a>			Screw- Hex
4	205254	<a href="#">W10175938</a>		Bolt
"	200744	<a href="#">W10175939</a>		Bolt
5	213100		Not Available	PART NOT USED
6	<a href="#">213054</a>			Centering Spring - 3 Used
7	<a href="#">203725</a>			Damper W/Bolt And Clip
8	<a href="#">203956</a>			Damper Pad Kit
9	<a href="#">213073</a>			Washer, Double Brace
10	214767	<a href="#">22001448</a>		Hose, Pump
11	213120	<a href="#">216416</a>		Bolt, Eye/Centering Spring
12	210186	<a href="#">3370225</a>		Screw
"	<a href="#">204807</a>			Ground Wire, Supp. Plte To Top Cover
13	<a href="#">Y212989</a>			Hose, Outer Tub To Pump
14	200461	<a href="#">285655</a>		Clamp, Hose

15	202574	<a href="#">3367052</a>	Clamp, Hose
16	Y311426	<a href="#">3400029</a>	Nut, Adapter Plate
17	<a href="#">205908</a>		Motor Mount Assembly
18	200816	<a href="#">6-2008160</a>	Pulley- MO
"	<a href="#">Y053241</a>		Set Screw, Motor Pulley
19	201805	<a href="#">12002351</a>	Motor-Drve
21	<a href="#">205999</a>		Motor Mount Assembly
22	205134	Not Available	MOTOR EXTERNAL START SWITCH
"	<a href="#">205131</a>		Switch, Motor External Start
"	205133	Not Available	(PROD. IDNo. 2-1664-8 & 2-5463)
"	<a href="#">206504</a>		Motor External Start Switch
"	206505	Not Available	PROD. No.201664-15, & No.205463-3.
"	205132	Not Available	SWITCH, MOTOR EXTERNAL START No.201664-14,205463-4 & 201800-4
23	213121	<a href="#">3400111</a>	Screw, 12-14 X 5/8
"	<a href="#">215098</a>		Shield, Motor
24	<a href="#">Y052734</a>		Nut, Carrage Bolts And Bracket
25	<a href="#">Y052785</a>		Nut, Brace To Damper
26	<a href="#">210385</a>		Lock Nut For Adjustable Leg
27	<a href="#">211949</a>		Nut, Adjustment Eyebolt
28	202203	<a href="#">6-2022030</a>	Pump As Pa
"	<a href="#">211880</a>		Screw, HeX Head No.10 X 1/2 Inc
"	Y015408	<a href="#">22003235</a>	Screw, Bearing Insert
29	204998	<a href="#">205000</a>	Roller And Spring Kit 4+Spr
30	<a href="#">205000</a>		Roller And Spring Kit 4+Spr
31	<a href="#">210684</a>		Foot, Adjustable Leg
32	<a href="#">202718</a>		Springs, Tension
33	206708	<a href="#">6-2097790</a>	Transmison
34	<a href="#">214956</a>		Motor Mount Assembly
35	<a href="#">Y054867</a>		Washer, Lock
36	<a href="#">211100</a>		Washer, Outer Tub
37	212979	Not Available	WASHER, TUB BRACE
38	911852	<a href="#">486009</a>	Lockwasher
39	211028	<a href="#">22001586</a>	Deflector, Water

