

Maytag LAT8440AAL 01 - BASE

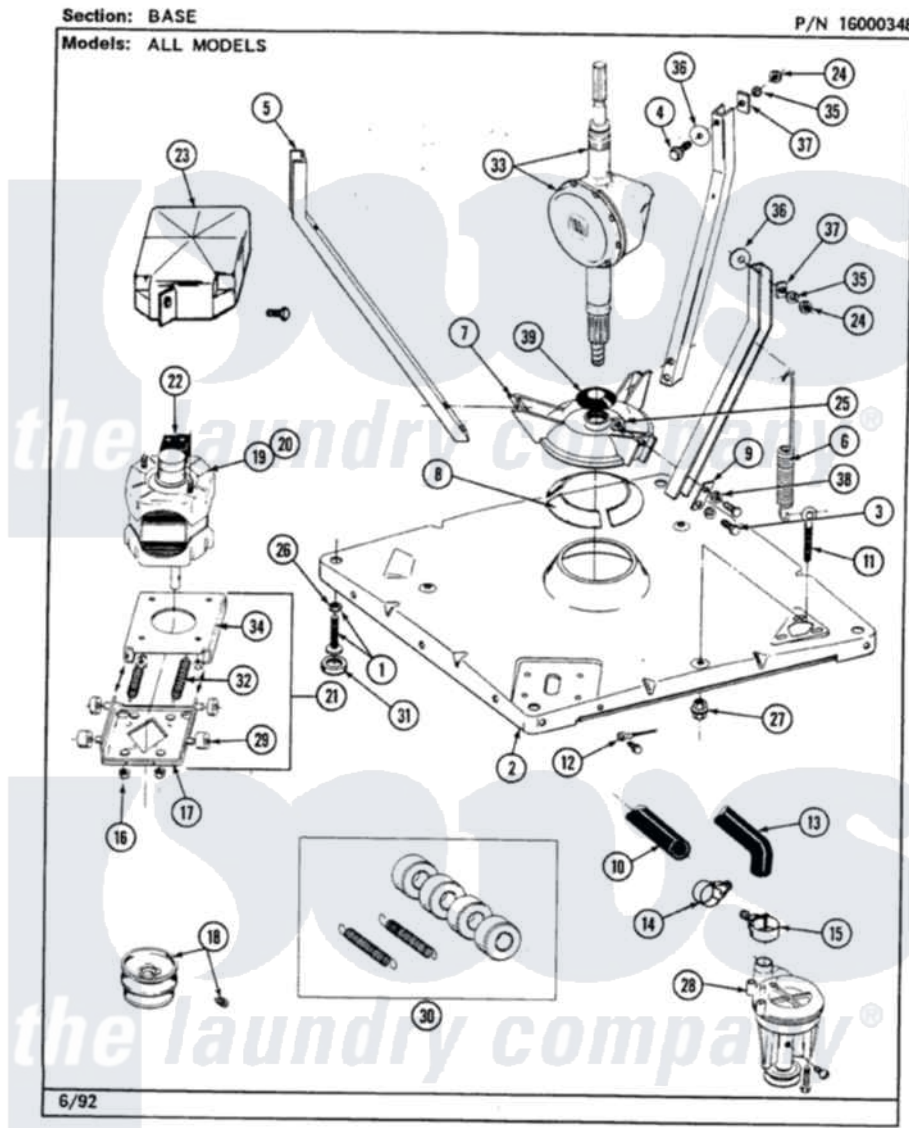

38

Maytag Residential Maytag LAT8440AAL Washer Parts Parts Diagram 01 - BASE
 Click on the part number to view part

Item	Original Part Number	Replaced By	Status	Part Description
1	Y302699	22003428		Leg, Adjustable
2	203274			Base With Damper Pads
3	Y015627			Screw- Hex
4	205254	W10175938		Bolt
"	200744	W10175939		Bolt
5	213100		Not Available	PART NOT USED
6	213054			Centering Spring - 3 Used
7	203725			Damper W/Bolt And Clip
8	203956			Damper Pad Kit
9	213073			Washer, Double Brace
10	214767	22001448		Hose, Pump
11	213120	216416		Bolt, Eye/Centering Spring
12	210186	3370225		Screw
"	204807			Ground Wire, Supp. Plte To Top Cover
13	Y212989			Hose, Outer Tub To Pump
14	200461	285655		Clamp, Hose

15	202574	3367052	Clamp, Hose
16	Y311426	3400029	Nut, Adapter Plate
17	205908		Motor Mount Assembly
18	200816	6-2008160	Pulley- MO
"	Y053241		Set Screw, Motor Pulley
20	201807	12002353	Motor-Drve
21	205999		Motor Mount Assembly
22	205134	Not Available	MOTOR EXTERNAL START SWITCH
"	205131		Switch, Motor External Start
"	205133	Not Available	(PROD. IDNo. 2-1664-8 & 2-5463)
"	206504		Motor External Start Switch
"	206505	Not Available	PROD. No.201664-15, & No.205463-3.
"	205132	Not Available	SWITCH, MOTOR EXTERNAL START No.201664-14,205463-4 & 201800-4
23	213121	3400111	Screw, 12-14 X 5/8
"	215098		Shield, Motor
24	Y052734		Nut, Carrage Bolts And Bracket
25	Y052785		Nut, Brace To Damper
26	210385		Lock Nut For Adjustable Leg
27	211949		Nut, Adjustment Eyebolt
28	202203	6-2022030	Pump As Pa
"	211880		Screw, HeX Head No.10 X 1/2 Inc
"	Y015408	22003235	Screw, Bearing Insert
29	204998	205000	Roller And Spring Kit 4+Spr
30	205000		Roller And Spring Kit 4+Spr
31	210684		Foot, Adjustable Leg
32	202718		Springs, Tension
33	206708	6-2097790	Transmison
34	214956		Motor Mount Assembly
35	Y054867		Washer, Lock
36	211100		Washer, Outer Tub
37	212979	Not Available	WASHER, TUB BRACE
38	911852	486009	Lockwasher
39	211028	22001586	Deflector, Water

