

# Maytag LAT9593AAW 05 - TOP COVER

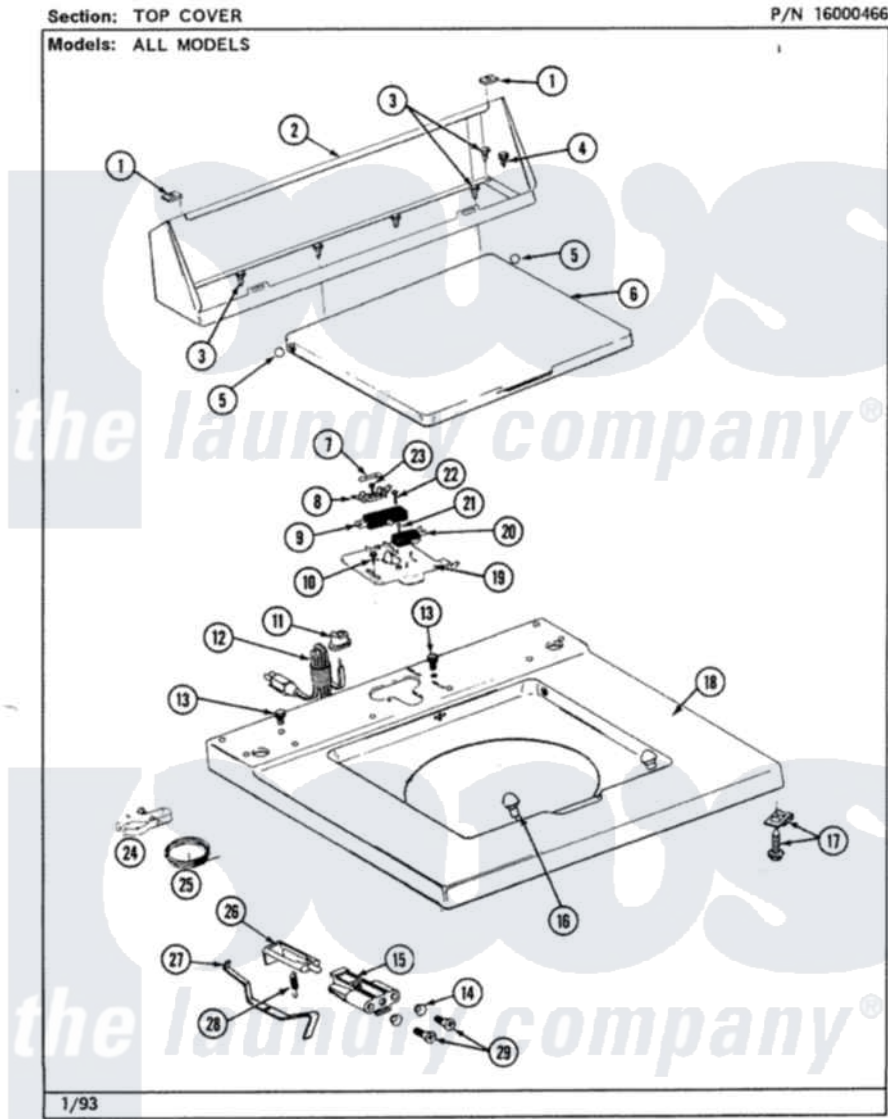

Maytag [Residential Maytag LAT9593AAW Washer Parts](#) Parts Diagram 05 - TOP COVER  
Click on the part number to view part

Item	Original Part Number	Replaced By	Status	Part Description
1	<a href="#">215075</a>			Fastener, Control Panel To Console
2	<a href="#">205635</a>			Console
3	211294	<a href="#">90767</a>		Screw, 8A X 3/8 HeX Washer Head Tapping
4	<a href="#">Y313559</a>			Screw
5	<a href="#">211726</a>			Hinge, Ball Lid
6	216073			LID (WHITE)
7	207168	<a href="#">22001682</a>		Switch Assembly, Lid W/4amp Fuse
8	<a href="#">207167</a>			Block, Fuse
9	205415	<a href="#">279347</a>		Switch-Lid
10	207159	<a href="#">489355</a>		Screw, 8 X 1/2
11	<a href="#">211881</a>			Grommet, Cord Part Not Used-Gas Models Only
12	210186	<a href="#">3370225</a>		Screw
"	208194	<a href="#">22003062</a>		Cord, Power
13	210186	<a href="#">3370225</a>		Screw

14	<a href="#">211500</a>		Washer, Bracket To Top Cover
15	214279	<a href="#">204968</a>	Plunger And Bracket Assembly--W
16	<a href="#">212716</a>		Bumper, Lid
17	<a href="#">204445</a>		Screw And Fastener Assembly
18	<a href="#">207172</a>		Top Cover
19	Y215699	<a href="#">22001678</a>	Bracket, Switch And Fuse
20	<a href="#">207166</a>		Switch, Check
21	912012	<a href="#">3400409</a>	Screw
22	<a href="#">213501</a>		Screw, No.6-20 X 1-1/8 Inch
23	<a href="#">Y311711</a>		Screw, Fuse Block
24	<a href="#">301548</a>		Clamp, Ground Wire
25	<a href="#">311155</a>		Ground Wire And Clamp
26	215700	Not Available	LID SWITCH PLUNGER
27	<a href="#">215704</a>		Lever, Unbalance
28	<a href="#">213720</a>		Spring, Lid Switch
29	910182	<a href="#">25-7809</a>	Screw, No.6-20 1/2 Flthd Torx

