

Maytag LAT9606AAM 01 - BASE

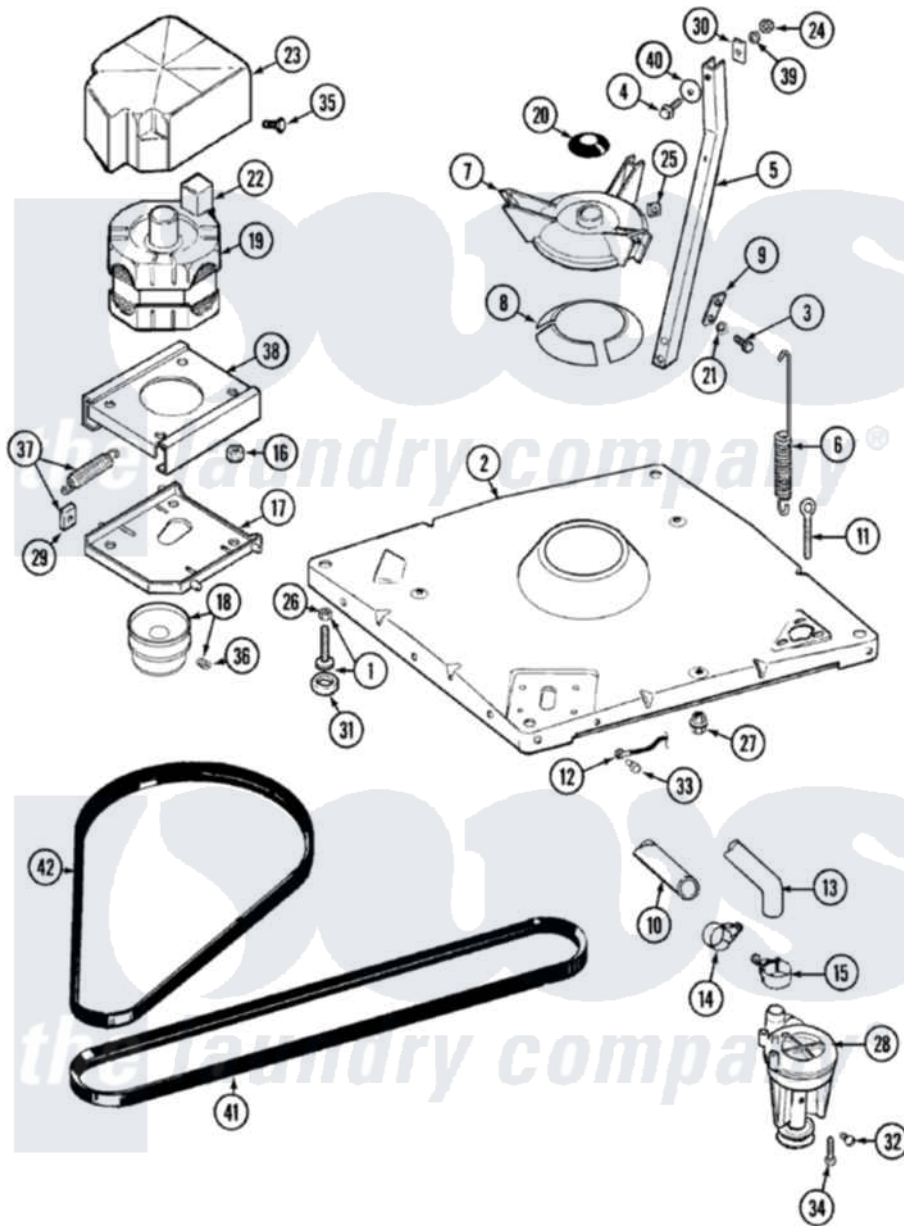

Maytag [Residential Maytag LAT9606AAM Washer Parts](#) Parts Diagram 01 - BASE
 Click on the part number to view part

Item	Original Part Number	Replaced By	Status	Part Description
1	Y302699	22003428		Leg, Adjustable
2	22001172	22002150		Base
3	Y015627			Screw- Hex
4	200744	W10175939		Bolt
"	205254	W10175938		Bolt
5	213053			Brace, Tub Part Not Used
6	22001300			Spring, Centering
7	203725			Damper W/Bolt And Clip
8	203956			Damper Pad Kit
9	213073			Washer, Double Brace
10	22001816			Hose, Drain
11	216416			Bolt, Eye/Centering Spring
12	901220			Ground Wire
13	213045			Hose, Outer Tub Part Not Used
14	22001820	285655		Clamp, Hose
15	22001640	285655		Clamp, Hose

16	Y311426	3400029	Nut, Adapter Plate
17	22001301		Mount, Motor Lower-Assembly
18	200816	6-2008160	Pulley- MO
19	201807	12002353	Motor-Drve
20	22001586		Deflector, Water
21	911852	486009	Lockwasher
22	206504		Motor External Start Switch
"	205131		Switch, Motor External Start
23	215098		Shield, Motor
24	Y052734		Nut, Carrage Bolts And Bracket
25	Y052785		Nut, Brace To Damper
26	210385		Lock Nut For Adjustable Leg
27	211949		Nut, Adjustment Eyebolt
28	202203	6-2022030	Pump As Pa
29	204998	205000	Roller And Spring Kit 4+Spr
30	212979	Not Available	WASHER, TUB BRACE
31	210684		Foot, Adjustable Leg
32	Y015408	22003235	Screw, Bearing Insert
33	Y705026	3370225	Screw
34	211880		Screw, HeX Head No.10 X 1/2 Inc
35	213121	3400111	Screw, 12-14 X 5/8
36	Y053241		Set Screw, Motor Pulley
37	205000		Roller And Spring Kit 4+Spr
38	214956		Motor Mount Assembly
39	Y054867		Washer, Lock
40	211100		Washer, Outer Tub
41	211124		Part Not Used
42	211125		V Belt, DriVe Pulley

