

Maytag LAT9606GGE 05 - TOP

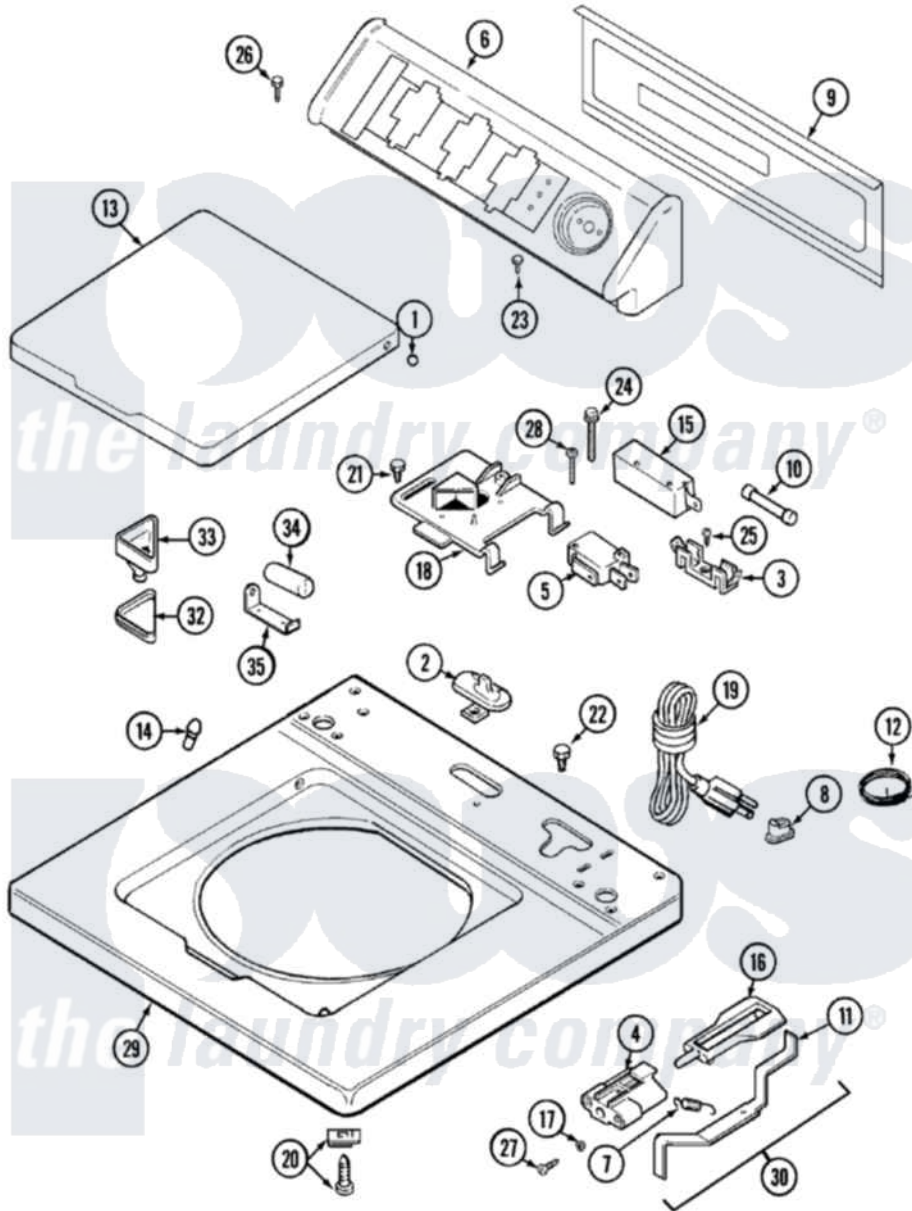

Maytag [Residential Maytag LAT9606GGE Washer Parts](#) Parts Diagram 05 - TOP
 Click on the part number to view part

Item	Original Part Number	Replaced By	Status	Part Description
1	211726			Hinge, Ball Lid
2	22001298			Cap, Top Cover
"	207159	489355		Screw, 8 X 1/2
3	207167			Block, Fuse
4	22001645		Not Available	BRACKET, UNBALANCE----NA
"	22002135			Bracket, Unbalance
5	207166			Switch, Check
6	22001670			Console
7	213720			Spring, Lid Switch
8	22002532	216183		Grommet, Cord Export
9	22001662	8534058		Screw
"	216423	3370225		Screw
"	22001814			Back Panel, Console
10	22001673	22001682		Switch Assembly, Lid W/4amp Fuse
11	22001672			Lever, Unbalance

"	22001968		Lever, Unbalance
12	22001654		Wire, Ground
"	Y705026	3370225	Screw
13	22001862		Not Available
			LID W/LEGEND (WHT)
14	212716		Bumper, Lid
15	22002383	22003813	Lid Switch
"	205415	279347	Switch-Lid
16	216255		Plunger, Lid Switch
17	211500		Washer, Bracket To Top Cover
18	22001678		Bracket, Switch And Fuse
19	22001558		Cord, Power
20	22001402	214354	Screw, Top Cover To Cabnt.
21	207159	489355	Screw, 8 X 1/2
22	Y705026	3370225	Screw
23	216423	3370225	Screw
24	213501		Screw, No.6-20 X 1-1/8 Inch
25	Y311711		Screw, Fuse Block
26	216423	3370225	Screw
27	22001600	25-7809	Screw, No.6-20 1/2 Flthd Torx
28	22001352		Screw, Check Switch
29	22001781	22002145	Cover Assembly, Top
"	216423	3370225	Screw
"	22002145		Cover Assembly, Top
"	22001920		Fuse
"	22001921	10091101	Block-Fuse
"	22001922		Sub-Harness
30	22001969		Unbalance Lever Assembly
"	22001681		Unbalance Lever Assembly
31	22001967	12001908	Switch-Lid
"	22001682		Switch Assembly, Lid W/4amp Fuse
32	215374		Not Available
			GASKET FOR BLEACH CUP
33	22001006		Cup, Bleach
34	211294	90767	Screw, 8A X 3/8 HeX Washer Head Tapping
"	201101		Capacitor
35	22001396		Clip, Capacitor

