

# Maytag LAT9615AAM 02 - CABINET

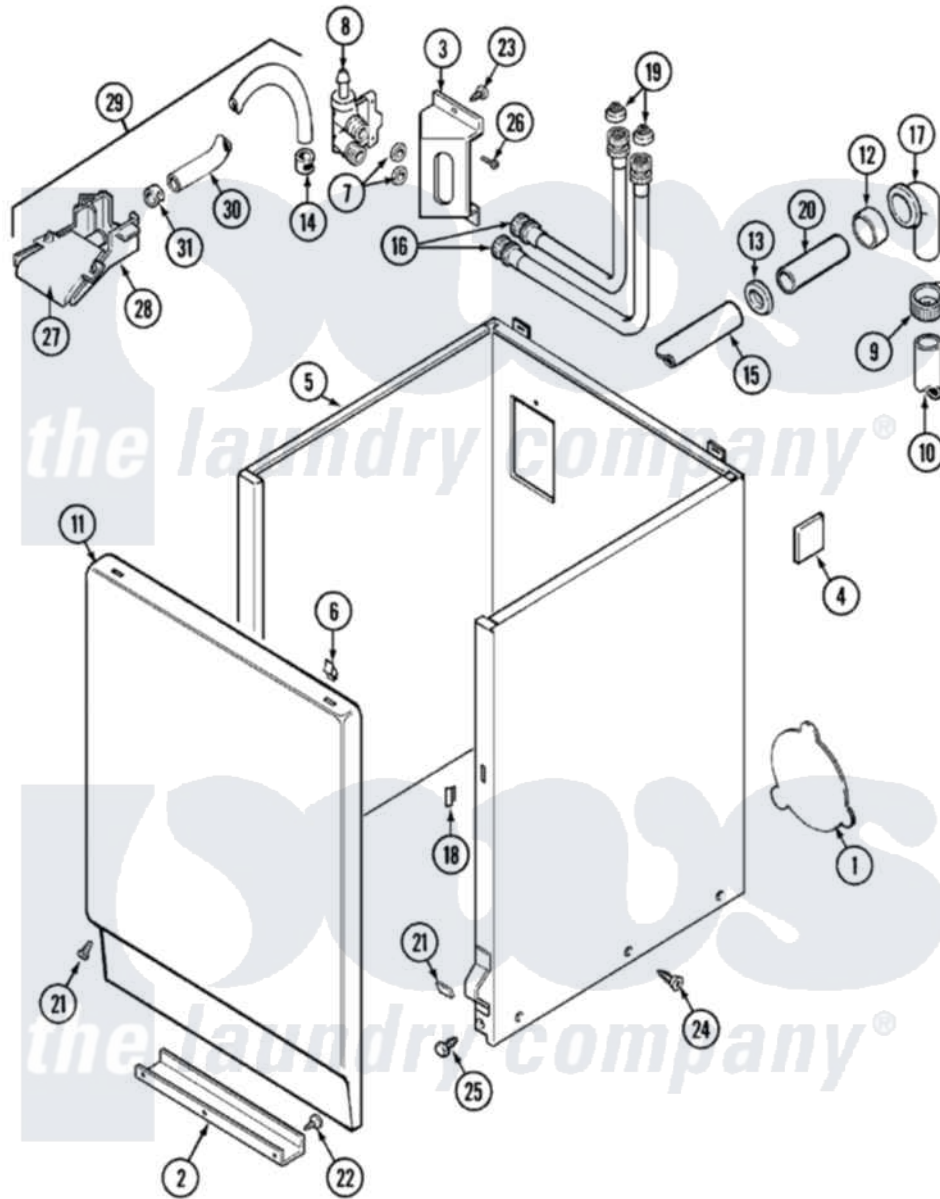

Maytag [Residential Maytag LAT9615AAM Washer Parts](#) Parts Diagram 02 - CABINET  
 Click on the part number to view part

Item	Original Part Number	Replaced By	Status	Part Description
1	211294	<a href="#">90767</a>		Screw, 8A X 3/8 HeX Washer Head Tapping
"	211878		Not Available	PLATE, ACCESS
2	<a href="#">213846</a>			Guard, Belt
3	214812	<a href="#">22002361</a>		Bracket, Water Valve
4	<a href="#">215058</a>			Pad, Cabinet Bumper
5	<a href="#">22001303</a>			Cabinet ---NA
6	212982	<a href="#">22001650</a>		Fastener, Spring
7	<a href="#">Y013783</a>			Washer, Inlet Hose
8	214337	<a href="#">96160</a>		Screen
"	<a href="#">22002360</a>			Valve, Water
9	200908	<a href="#">285655</a>		Clamp, Hose
10	<a href="#">216017</a>			Hose, Drain
"	<a href="#">Y059149</a>			(7/8" I.D. CARTON OF 50 FT.)
11	33001221	<a href="#">22001817</a>		Sheet, Sound Damper
"	216078L		Not Available	PANEL, FRONT (ALM) SUB

12	<a href="#">214765</a>		Gasket, Siphon Break
13	202574	<a href="#">3367052</a>	Clamp, Hose
14	216169	<a href="#">596669</a>	Clamp, Manifold
15	214767	<a href="#">22001448</a>	Hose, Pump
16	<a href="#">202860</a>		Inlet Hose Assembly
17	Y216016	<a href="#">W10116738</a>	Elbow
18	214376	<a href="#">22002331</a>	Spacer, Front Panel
19	200961	<a href="#">12001413</a>	Strainer And Washer Kit
20	<a href="#">Y014874</a>		Screw, Idler Arm And Sleeve
"	<a href="#">206638</a>		Siphon Break
21	<a href="#">204439</a>		Screw And Fstner Assembly
22	211294	<a href="#">90767</a>	Screw, 8A X 3/8 HeX Washer Head Tapping
23	212276	<a href="#">W10116760</a>	Screw
24	<a href="#">213007</a>		Xfor Cabinet See Cabinet, Back
25	213121	<a href="#">3400111</a>	Screw, 12-14 X 5/8
"	213122	<a href="#">27001200</a>	Screw
26	<a href="#">Y313561</a>		Screw----NA
27	<a href="#">22001187</a>		Injector
28	<a href="#">22001186</a>		Injector
29	<a href="#">22001304</a>		Water Injector Assembly
30	<a href="#">22001190</a>		Hose, Injector
31	216170	<a href="#">489503</a>	Clamp

