

Maytag LDE8420 04 - INLET DUCT & HEATER ASSEMBLY

SECTION: INLET DUCT & HEATER ASSEMBLY
 MODEL: DE MODELS

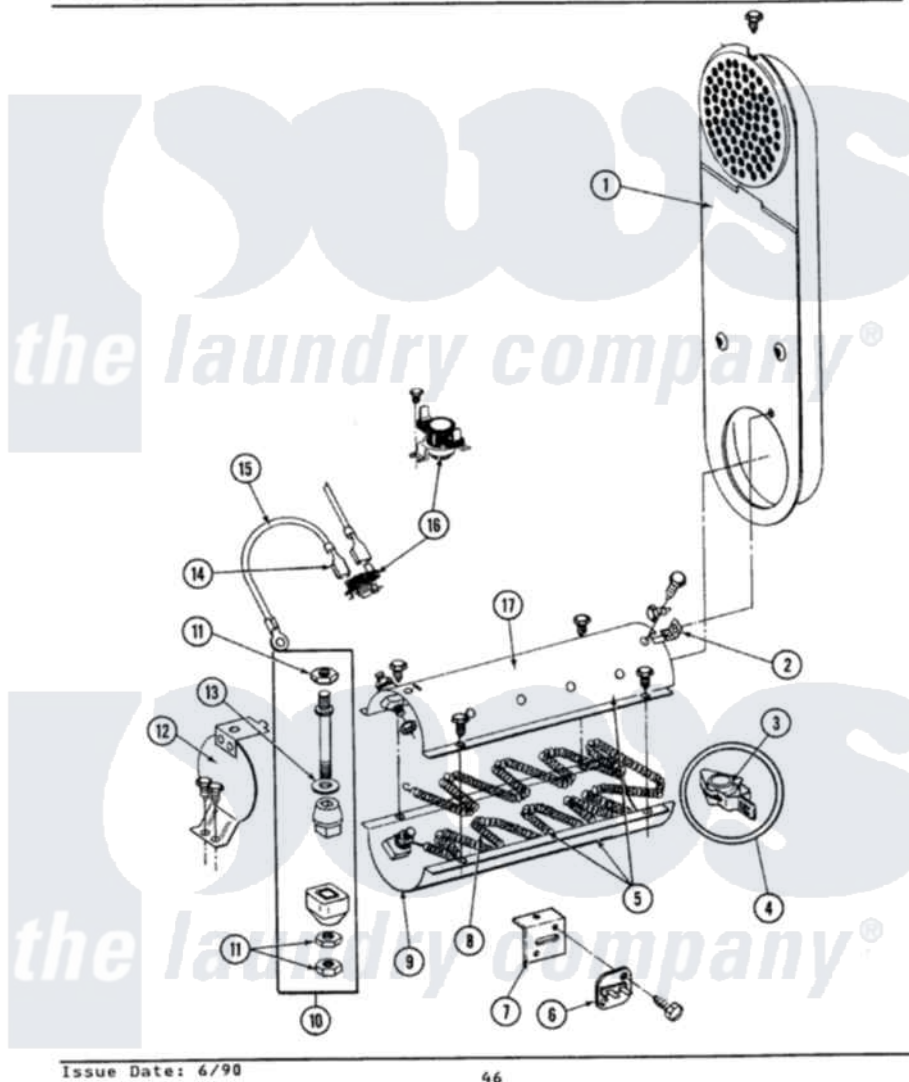

Issue Date: 6/90

46

Maytag [Residential Maytag LDE8420 Dryer Parts](#) Parts Diagram 04 - INLET DUCT & HEATER ASSEMBLY
 Click on the part number to view part

Item	Original Part Number	Replaced By	Status	Part Description
1	211294	90767		Screw, 8A X 3/8 HeX Washer Head Tapping
"	307120		Not Available	INLET DUCT ASSY.
2	211294	90767		Screw, 8A X 3/8 HeX Washer Head Tapping
"	Y312890			Retainer, Heater Chamber
3	Y313270			Insulator For Heater Elemen
4	Y303881			Clip And Insulator Assembly
5	211294	90767		Screw, 8A X 3/8 HeX Washer Head Tapping
"	Y303778			Heater Assembly Complete
6	307473			Fuse, Thermal
"	314848	W10116760		Screw
7	315046			MOUNTING BRACKET
"	211294	90767		Screw, 8A X 3/8 HeX Washer Head Tapping
8	Y313538			Heater Element 240 Volt
9	Y313576			Heater Chamber, Bottom

10	Y304596		Terminal Insulator Assembly
11	311484	112432	Nut
12	211294	90767	Screw, 8A X 3/8 HeX Washer Head Tapping
"	304124		Not Available HEATER SHIELD
13	311093		Washer, Terminal Connection
14	210745		Wire Terminal
15	Y304693		Jumper Wire
16	303396		Thermostat, Hi-Limit
"	211294	90767	Screw, 8A X 3/8 HeX Washer Head Tapping
"	303896		Hi-Limit Thermostat-Canada
17	211294	90767	Screw, 8A X 3/8 HeX Washer Head Tapping
"	Y313575		Not Available HEATER CHAMBER, TOP

