

# Maytag LDG8600ABL 05 - GAS VALVE

Section: GAS VALVE

P/N 160002E

Models: ALL LDG MODELS

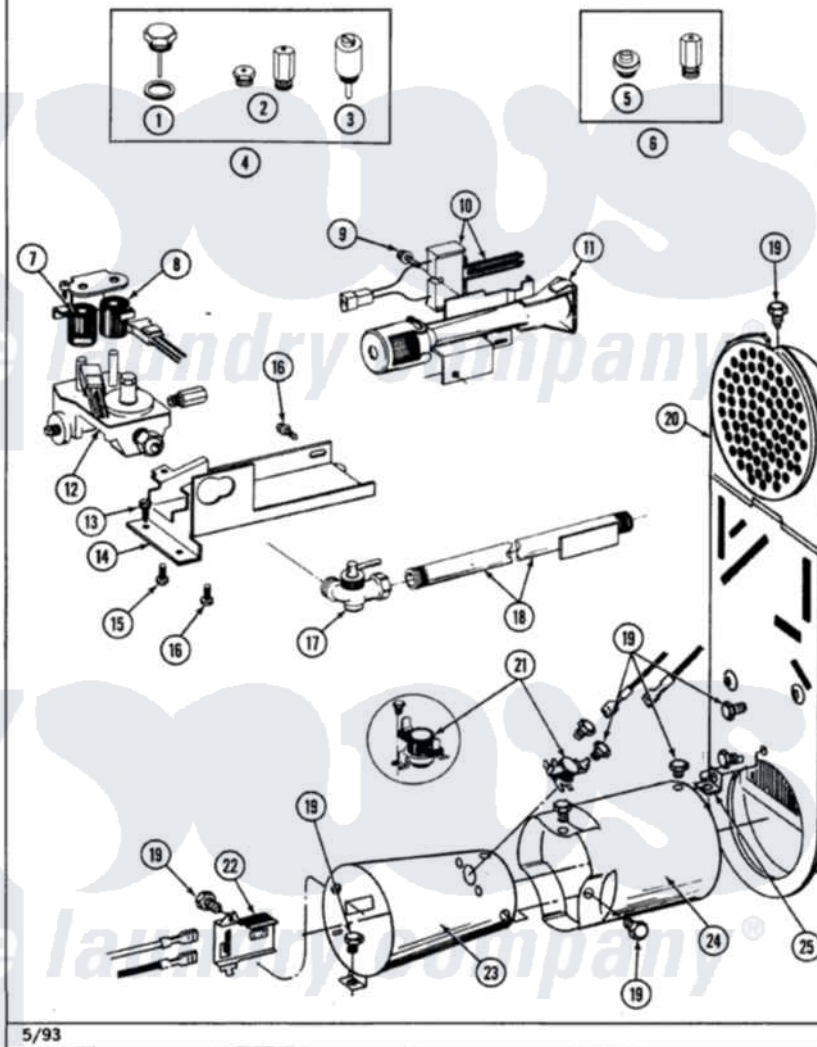

5/93

Maytag [Residential Maytag LDG8600ABL Dryer Parts](#) Parts Diagram 05 - GAS VALVE

[Click on the part number to view part](#)

Item	Original Part Number	Replaced By	Status	Part Description
1	<a href="#">302810</a>			Screw Assembly - Blue Block Ope
2	305861		Not Available	MAIN BURNER ORIFICE KIT-LPG
3	306184		Not Available	PLUG, BLOCKING (LPG REGULATOR)
4	Y306195	<a href="#">MAL9000AXX</a>		LP Gas Con
5	314602	<a href="#">694424</a>		Leak, Limiter
6	306204	<a href="#">33002924</a>		Gas Conv K
7	<a href="#">306106</a>			Coil, Holding And Booster-W
8	306105	<a href="#">694540</a>		Coil, 60 Hz
9	<a href="#">304971</a>			Screw Note: Screw, Igniter
10	304970	<a href="#">4391996</a>		Ignitor
11	304974	<a href="#">33002793</a>		Burner Assembly
12	<a href="#">306176</a>			Valve, Gas
13	<a href="#">Y313561</a>			Screw---NA
14	<a href="#">314566</a>			Gas Control Bracket

15	314082	<a href="#">90767</a>	Screw, 8A X 3/8 HeX Washer Head Tapping
16	<a href="#">Y313559</a>		Screw
17	<a href="#">Y303349</a>		Angle Shut-Off, Gas Valve
18	Y303383	<a href="#">33001735</a>	Pipe And Bracket Assembly Series 18 Not Needed Use Vavle
19	211294	<a href="#">90767</a>	Screw, 8A X 3/8 HeX Washer Head Tapping
20	Y308504	Not Available	INLET DUCT ASSEMBLY
"	<a href="#">307119</a>		Duct, Inlet Assembly
21	<a href="#">303395</a>		Thermostat, Hi-Limit
22	Y303377	<a href="#">338906</a>	Radiant, Sensor
23	<a href="#">Y308548</a>		Combustion Cone Assembly
"	<a href="#">Y303368</a>		Cone, Combustion
24	<a href="#">Y303841</a>		Cone, Extension
25	<a href="#">Y312890</a>		Retainer, Heater Chamber

