

Maytag LDG9900AAL 05 - GAS VALVE

Section: GAS VALVE

P/N 160002E

Models: ALL LDG MODELS

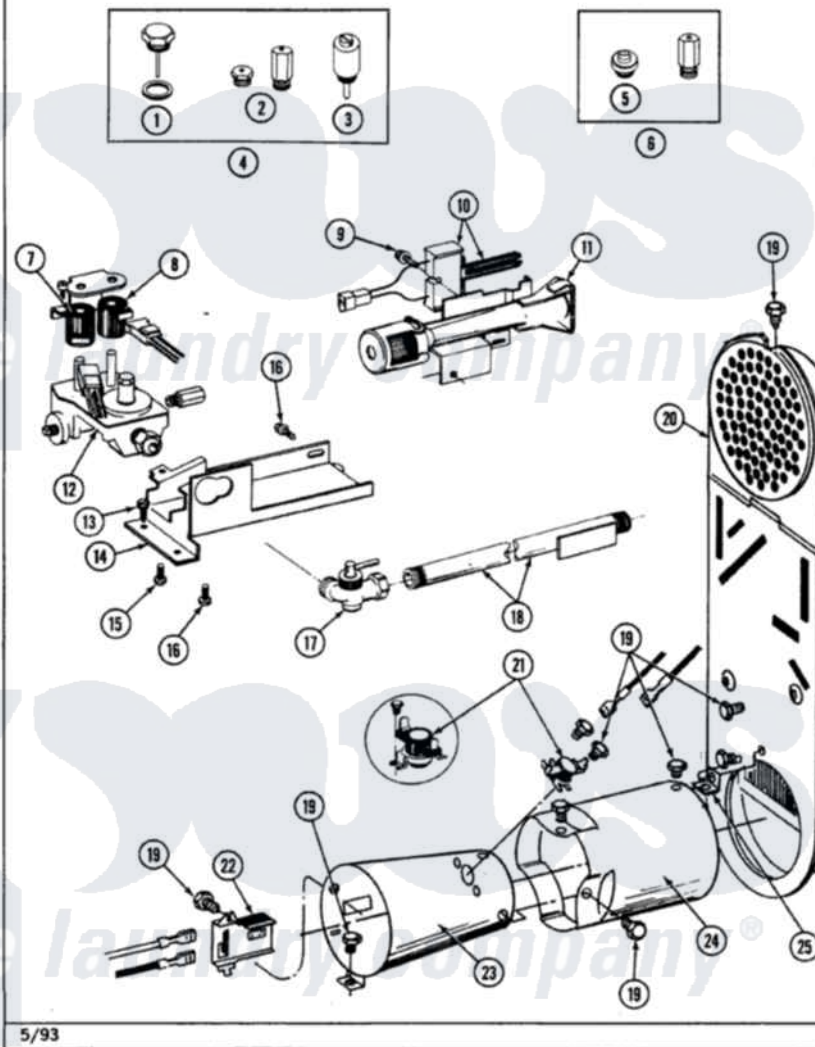

5/93

Maytag [Residential Maytag LDG9900AAL Dryer Parts](#) Parts Diagram 05 - GAS VALVE

[Click on the part number to view part](#)

Item	Original Part Number	Replaced By	Status	Part Description
1	302810			Screw Assembly - Blue Block Ope
2	305861		Not Available	MAIN BURNER ORIFICE KIT-LPG
3	306184		Not Available	PLUG, BLOCKING (LPG REGULATOR)
4	Y306195	MAL9000AXX		LP Gas Con
5	314602	694424		Leak, Limiter
6	306204	33002924		Gas Conv K
7	306106			Coil, Holding And Booster-W
8	306105	694540		Coil, 60 Hz
9	304971			Screw Note: Screw, Igniter
10	304970	4391996		Ignitor
11	304974	33002793		Burner Assembly
12	306176			Valve, Gas
13	Y313561			Screw---NA
14	314566			Gas Control Bracket

15	314082	90767	Screw, 8A X 3/8 HeX Washer Head Tapping
16	Y313559		Screw
17	Y303349		Angle Shut-Off, Gas Valve
18	Y303383	33001735	Pipe And Bracket Assembly Series 18 Not Needed Use Vavle
19	211294	90767	Screw, 8A X 3/8 HeX Washer Head Tapping
20	Y308504	Not Available	INLET DUCT ASSEMBLY
"	307119		Duct, Inlet Assembly
21	303395		Thermostat, Hi-Limit
22	Y303377	338906	Radiant, Sensor
23	Y308548		Combustion Cone Assembly
"	Y303368		Cone, Combustion
24	Y303841		Cone, Extension
25	Y312890		Retainer, Heater Chamber

