

# Maytag MAT26PCABG 04 - TUB COVER

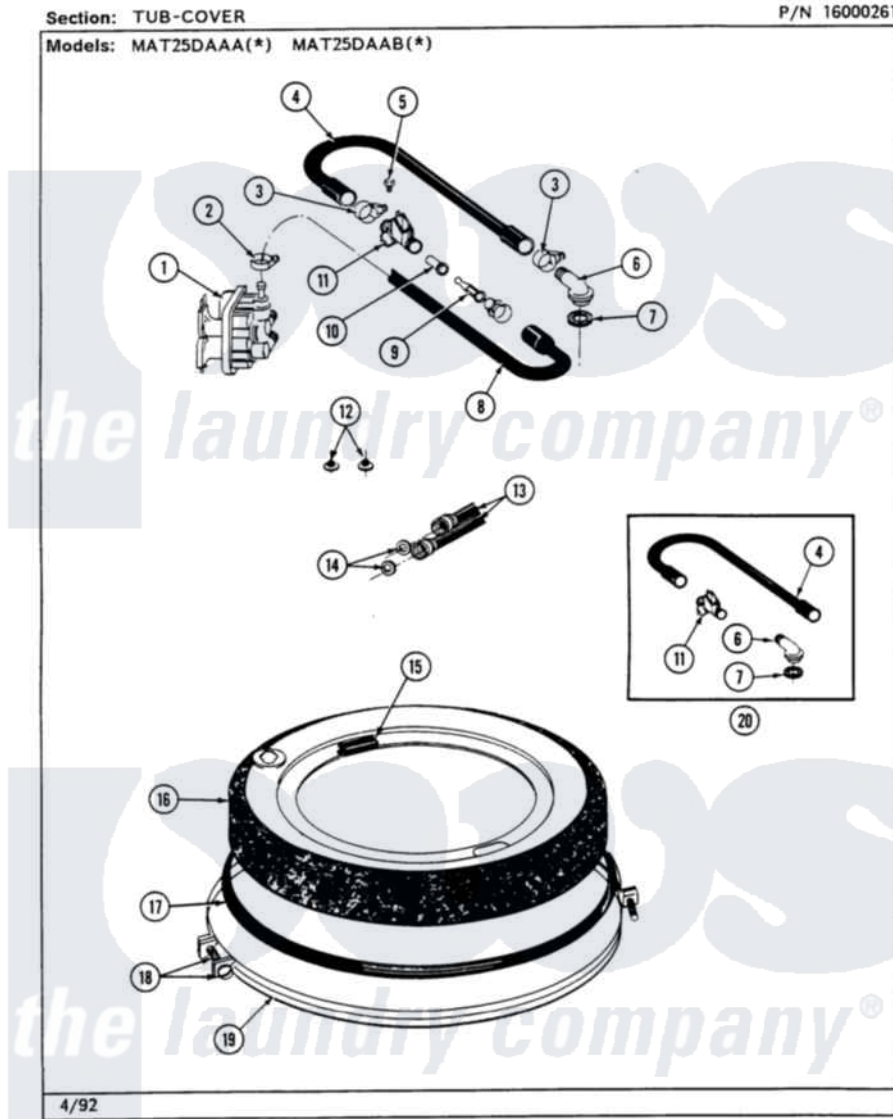

10

Maytag [Residential Maytag MAT26PCABG Washer Parts](#) Parts Diagram 04 - TUB COVER  
 Click on the part number to view part

Item	Original Part Number	Replaced By	Status	Part Description
001	205614	<a href="#">205613</a>		Water Valve
002	<a href="#">201575</a>			Clamp, Hose
003	202515	<a href="#">596669</a>		Clamp, Manifold
004	<a href="#">Y215234</a>			Hose, Injector Fill
005	<a href="#">312620</a>			Screw, Sems
006	<a href="#">215235</a>			Tube, Injector
007	<a href="#">215233</a>			Seal For Injector Tube
008	<a href="#">213013</a>			Hose, Injector
009	<a href="#">213015</a>			Nozzle, Injector
010	213016	<a href="#">216201</a>		Nozzle
011	<a href="#">215447</a>			Sleeve For Injector
012	200961	<a href="#">12001413</a>		Strainer And Washer Kit
013	205828	<a href="#">202860</a>		Inlet Hose Assembly
014	<a href="#">Y013783</a>			Washer, Inlet Hose
015	<a href="#">215232</a>			Bumper, Unbalance
016	206380		Not Available	COVER, TUB

017

[211232](#)

Seal, Tub Cover

018

[205529](#)

Nut And Bolt Kit For Tub Clam

019

[200846](#)

Clamp - Tub Cover

020

206683

[206680](#)

Water Injector Assembly

