

# Maytag MAV6601AWQ 06 - TRANSMISSION

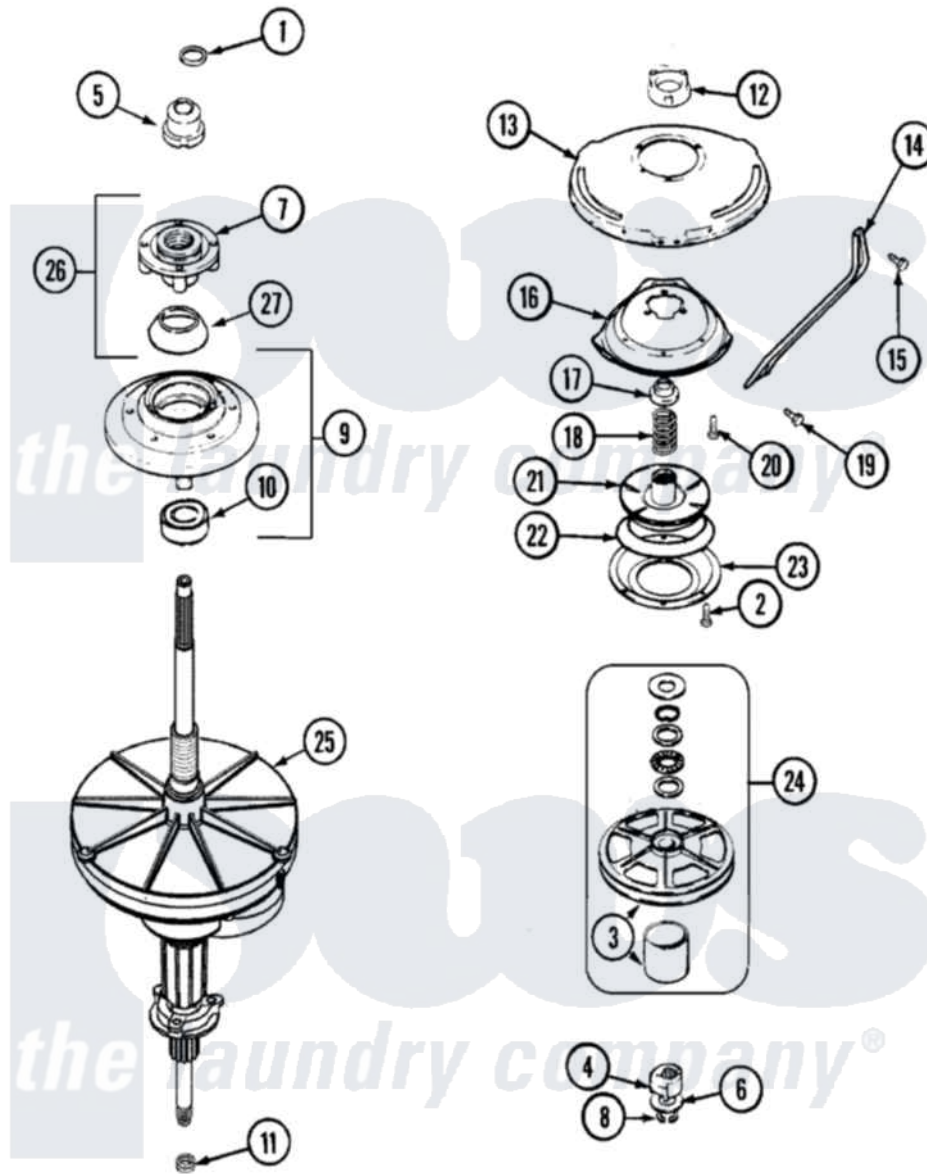

Maytag [Residential Maytag MAV6601AWQ Washer Parts](#) Parts Diagram 06 - TRANSMISSION  
 Click on the part number to view part

Item	Original Part Number	Replaced By	Status	Part Description
1	<a href="#">25-7941</a>			"O" Ring, Agr Drive Shaft
2	<a href="#">21001065</a>			Screw, No.10-24 x .50 Hxnibhd
3	12001797	<a href="#">12002213</a>		Thrust Bearing Kit
4	LA-2007	<a href="#">12002213</a>		Thrust Bearing Kit
5	21001533	<a href="#">35-5655-1</a>		Seal
6	<a href="#">35-2132</a>			Washer, 1.25ODX.530IDX.032
"	<a href="#">35-2082</a>			Washer, 1.25ODX.530IDX.062
7	21001515	<a href="#">12001598</a>		Tub Seal Assembly--W
"	<a href="#">35-3685</a>			Gasket, Basket To Centerpost
8	<a href="#">25-7854</a>			Ring, Retaining
9	<a href="#">12001598</a>			Tub Seal Assembly--W
10	<a href="#">35-2205</a>			Bearing, Spin
11	35-2010	<a href="#">207843</a>		Lip Seal Repair Kit
12	<a href="#">35-2205</a>			Bearing, Spin
"	21001511	<a href="#">12001562</a>		Bearing Assembly
13	<a href="#">21001518</a>			Support, Tub

14	<a href="#">21001532</a>		Brace, Tub
15	25-7895	<a href="#">21001858</a>	Screw 5/16-18 x 1/2
16	<a href="#">21001163</a>		Housing, Suspension
17	<a href="#">35-2017</a>		Retainer, Brake Spring
18	31001285	<a href="#">21001910</a>	Spring, Brake
19	25-7930	<a href="#">21001858</a>	Screw 5/16-18 x 1/2
20	<a href="#">21001509</a>		Screw, High Performance Plastic
21	35-2948	<a href="#">35-6714</a>	Brake Roto
22	21001161	<a href="#">21002026</a>	Snubber
23	35-2018	<a href="#">35-6918</a>	Stator, Brake
24	12500036	<a href="#">12002213</a>	Thrust Bearing Kit
25	21001536	<a href="#">35-6615</a>	Ht TranS S
"	21001867	<a href="#">35-6615</a>	Ht TranS S
26	21001868	<a href="#">W10219156</a>	Tub Seal
"	21001508	<a href="#">12001561</a>	Bearing And Seal Housing Assembly
27	<a href="#">35-2974</a>		Tub Seal/Hub Assembly

