

Maytag MAV8500AWQ 02 - TRANSMISSION

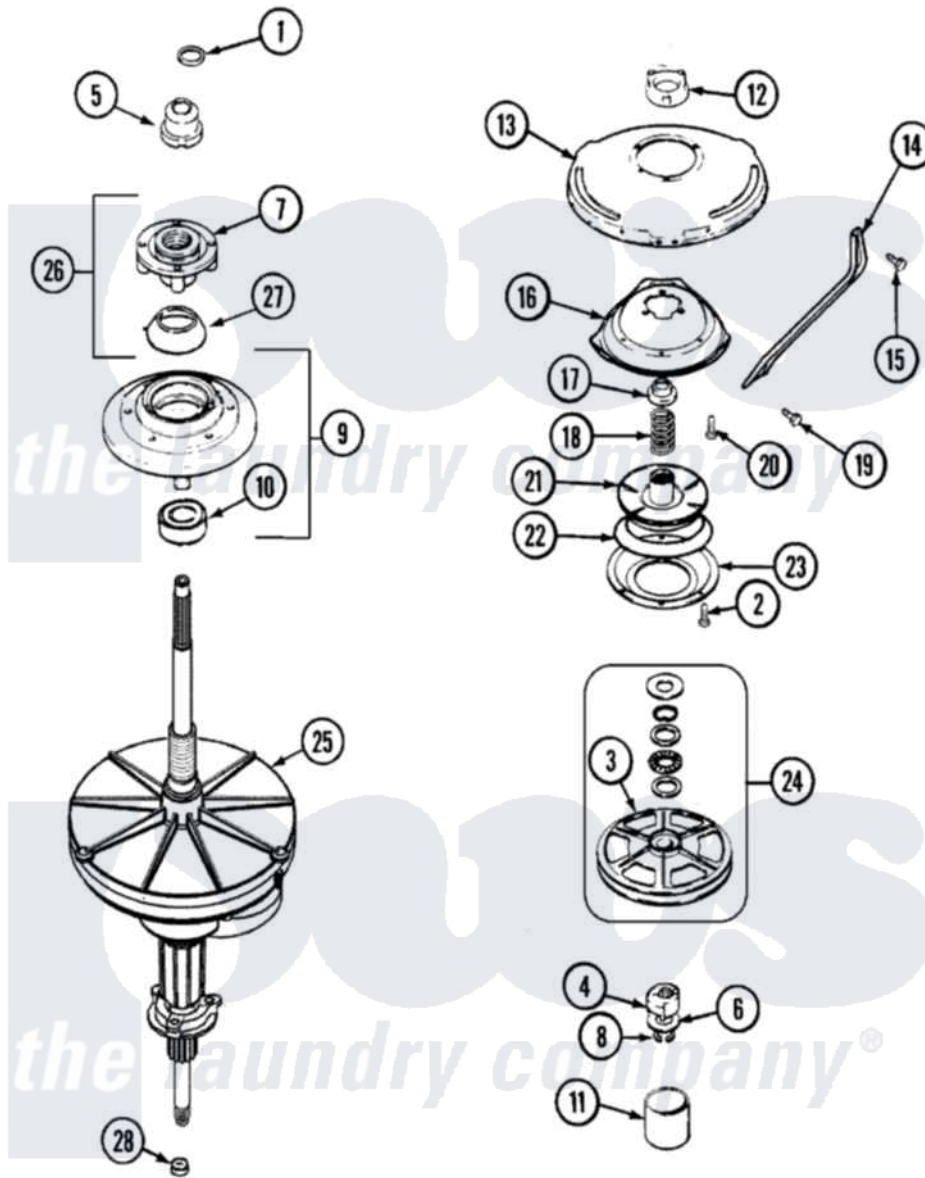

Maytag [Residential Maytag MAV8500AWQ Washer Parts](#) Parts Diagram 02 - TRANSMISSION
 Click on the part number to view part

| Item | Original Part Number | Replaced By | Status | Part Description |
|------|--------------------------|---------------------------|---------------|-----------------------------------|
| 1 | 25-7941 | | | "O" Ring, Agr Drive Shaft |
| 2 | 21001065 | | | Screw, No.10-24 x .50 Hxnibhd |
| 3 | 35-3829 | 12002213 | | Thrust Bearing Kit |
| " | 12001797 | 12002213 | | Thrust Bearing Kit |
| 4 | LA-2007 | 12002213 | | Thrust Bearing Kit |
| 5 | 21001533 | 35-5655-1 | | Seal |
| 6 | 35-2132 | | | Washer, 1.25ODX.530IDX.032 |
| " | 35-2082 | | | Washer, 1.25ODX.530IDX.062 |
| 7 | 21001515 | 12001598 | | Tub Seal Assembly--W |
| 8 | 25-7854 | | | Ring, Retaining |
| 9 | 21001508 | 12001561 | | Bearing And Seal Housing Assembly |
| 10 | 35-2205 | | | Bearing, Spin |
| 11 | W10124350 | | Not Available | NOT REQUIRED PART OR SEE NOTE |
| " | 35-2007 | | | Cap, Dust |
| 12 | 35-2205 | | | Bearing, Spin |

| | | | |
|----|--------------------------|--------------------------|---------------------------------|
| " | 21001511 | 12001562 | Bearing Assembly |
| 13 | 21001518 | | Support, Tub |
| 14 | 21001532 | | Brace, Tub |
| 15 | 25-7895 | 21001858 | Screw 5/16-18 x 1/2 |
| 16 | 21001163 | | Housing, Suspension |
| 17 | 35-2017 | | Retainer, Brake Spring |
| 18 | 31001285 | 21001910 | Spring, Brake |
| 19 | 25-7930 | 21001858 | Screw 5/16-18 x 1/2 |
| 20 | 21001509 | | Screw, High Performance Plastic |
| 21 | 35-2948 | 35-6714 | Brake Roto |
| 22 | 21001161 | 21002026 | Snubber |
| 23 | 35-2018 | 35-6918 | Stator, Brake |
| 24 | 12500036 | 12002213 | Thrust Bearing Kit |
| 25 | 21001536 | 35-6615 | Ht TranS S |
| 26 | 12001598 | | Tub Seal Assembly--W |
| 27 | 35-2974 | | Tub Seal/Hub Assembly |
| 28 | 35-2010 | 207843 | Lip Seal Repair Kit |

