

Maytag MED5620TQ0 02 - CABINET PARTS

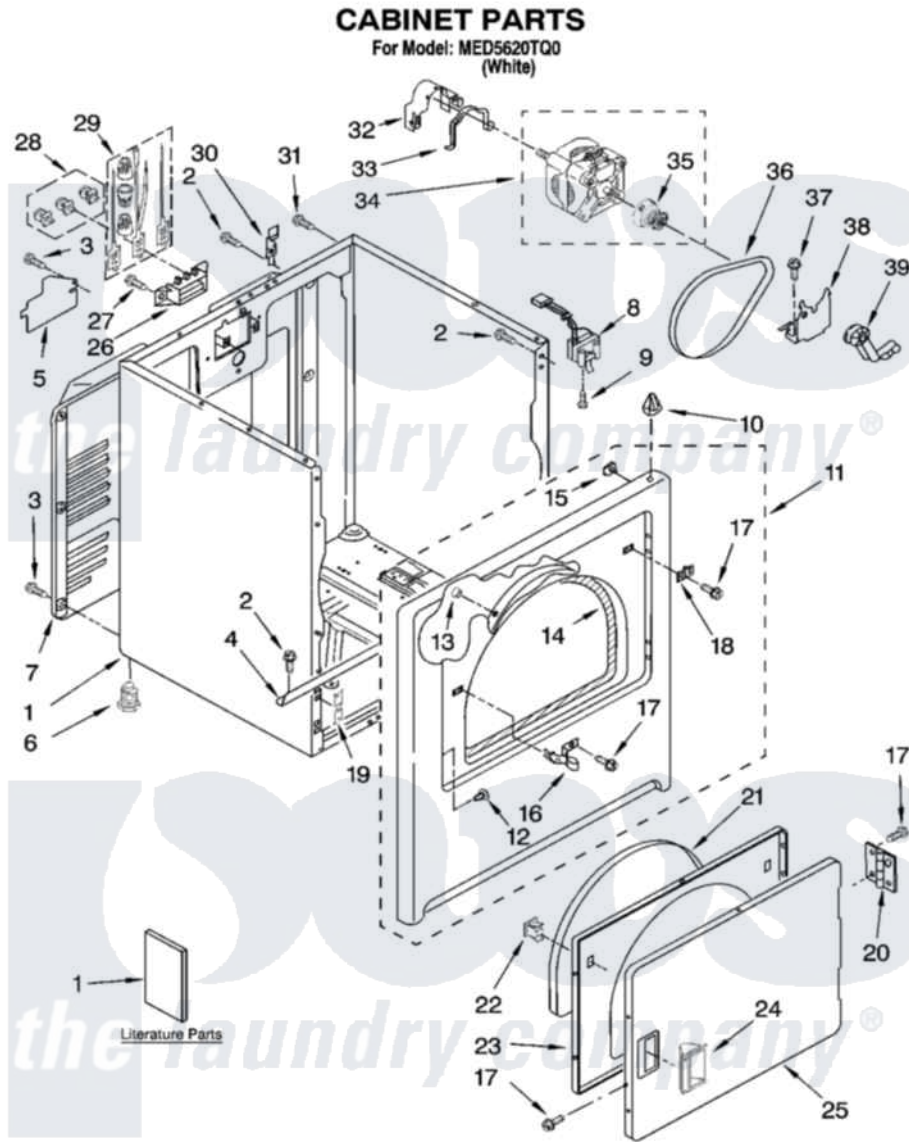

W10117901

3

Maytag [Residential Maytag MED5620TQ0 Dryer Parts](#) Parts Diagram 02 - CABINET PARTS
Click on the part number to view part

Item	Original Part Number	Replaced By	Status	Part Description
1	8530603	8533643		Cabinet
2	343641	681414		Screw, 10AB X 1/2
3	693995			Screw, Hex Head
4	8541400			Bracket, Cabinet
5	3396795			Cover, Terminal Block
6	3392100	49621		Feet-Leveling
"	279810			Foot-Optional
7	3396805	280043		Panel-Rear
8	3406107			Door Switch Assembly
9	697773	3395530		Screw
10	690363	18776		Lock, Front Top
11	3403444	279852		Panel
12	3404413			Plug, Hinge Hole
13	685203	279220		Clip
14	3406129			Seal And Bearing Assembly
15	98234			Clip, U-Bend

16	3403431		Strike, Panel
17	342055	488627	Screw
18	3403630		Plug, Strike Hole
19	3394083		Clip, Front Panel
20	3405514	W10362431	Hinge And Pin Assembly
21	3405246		Seal, Door Push-To-Start
22	3389441		Door Catch Assembly
23	3402341		Door, Inner
24	8565970		Handle, Door
25	3402335		Door, Front
26	3397659		Block, Terminal
27	3393008	308685	Side Trim)
28	279393		Terminal Block Screw Kit
29	279318		Terminal Tinned And Brass Panel
30	8066217		Hinge, Top
31	697776	4331106	Screw, No.10-32 X 7/16
32	3404162		Clamp, Motor
33	660658		Clamp, Motor Mounting 343481 685441
34	8066206	279827	Motor-Drve
35	8066184		Pulley, Motor
36	W10131364	341241	Belt
37	3400500		Bolt, 3405245 5/16-18 X 3/4
38	348780		Base, Motor
39	691366		Idler And Pulley Assembly

the laundry company[®]

the laundry company[®]