

Maytag MET3800TW1 03 - DRYER CABINET AND MOTOR PARTS

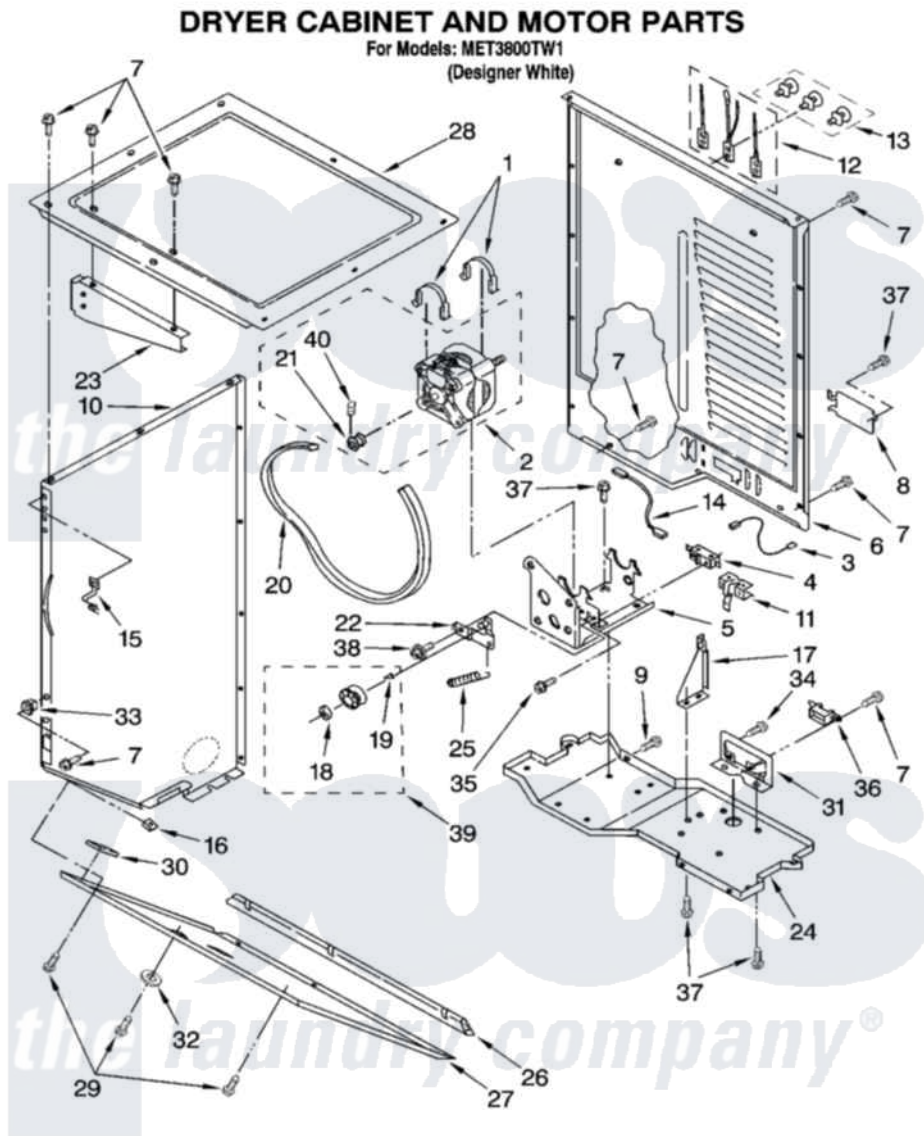

IMPORTANT: All Part Numbers Listed Are Whirlpool Numbers. Source Parts Through Whirlpool.

W10143040

3

Maytag [Residential Maytag MET3800TW1 Washer/Dryer Parts](#) Parts Diagram 03 - DRYER CABINET AND MOTOR PARTS

[Click on the part number to view part](#)

Item	Original Part Number	Replaced By	Status	Part Description
1	660658			Clamp, Motor Mounting 343481 685441
2	8538266	279811		Motor-Drve
3	3398948			Wire, Jumper
4	3394881	279782		Switch-Lid
5	3388858			Bracket, Motor
6	3389847	280039		Panel
7	343641	681414		Screw, 10AB X 1/2
8	3387673	279814		Cover
9	8533974	4331106		Screw, No.10-32 X 7/16
10	3389264			Panel, Side
"	3389256			Panel, Side
11	8066120			Lever, Door Switch
12	279318			Terminal Tinned And Brass Panel
13	279393			Terminal Block Screw Kit

14	3394081		Wire, Broken Belt Switch
15	3389231		Clip, Front Panel
16	98234		Clip, U-Bend
17	3391639		Bracket, Bulkhead
18	690997		Washer, Thrust
19	W10121334		Washer, Thrust
20	3387610	661570	Belt
21	3391087	279811	Motor-Drive
22	3389332	3389331	Pulley, Idler
23	3390722		Shield, Console To Drum
24	3390026		Base, Dryer
25	3387374		Spring, Idler
26	3389683		Cove, Transition Panel
27	3389272		Panel, Transition
28	3389537		Top, Dryer
29	693304		Screw And Washer
30	3389682		Space-Toe Panel User-Interface
31	3393722		Bracket, Terminal Block
32	3389431		Bumper, Lid Stop
33	692400		Nut, Push-In
34	3387485	273556	Screw, 10-16 X 5/8
35	98129		Screw, 6-20 X 1 1/16
36	3397659		Block, Terminal
37	3390631		Screw, 10-16 X 3/8
38	3389420		Retainer-Idler 1/4-20 X 1/16
39	3388672	279640	Pulley-Idr
40	3394743	Not Available	Pin, Roll

the laundry company[®]

the laundry company[®]