

# Whirlpool GHW9160PW3 01 - TOP AND CABINET PARTS

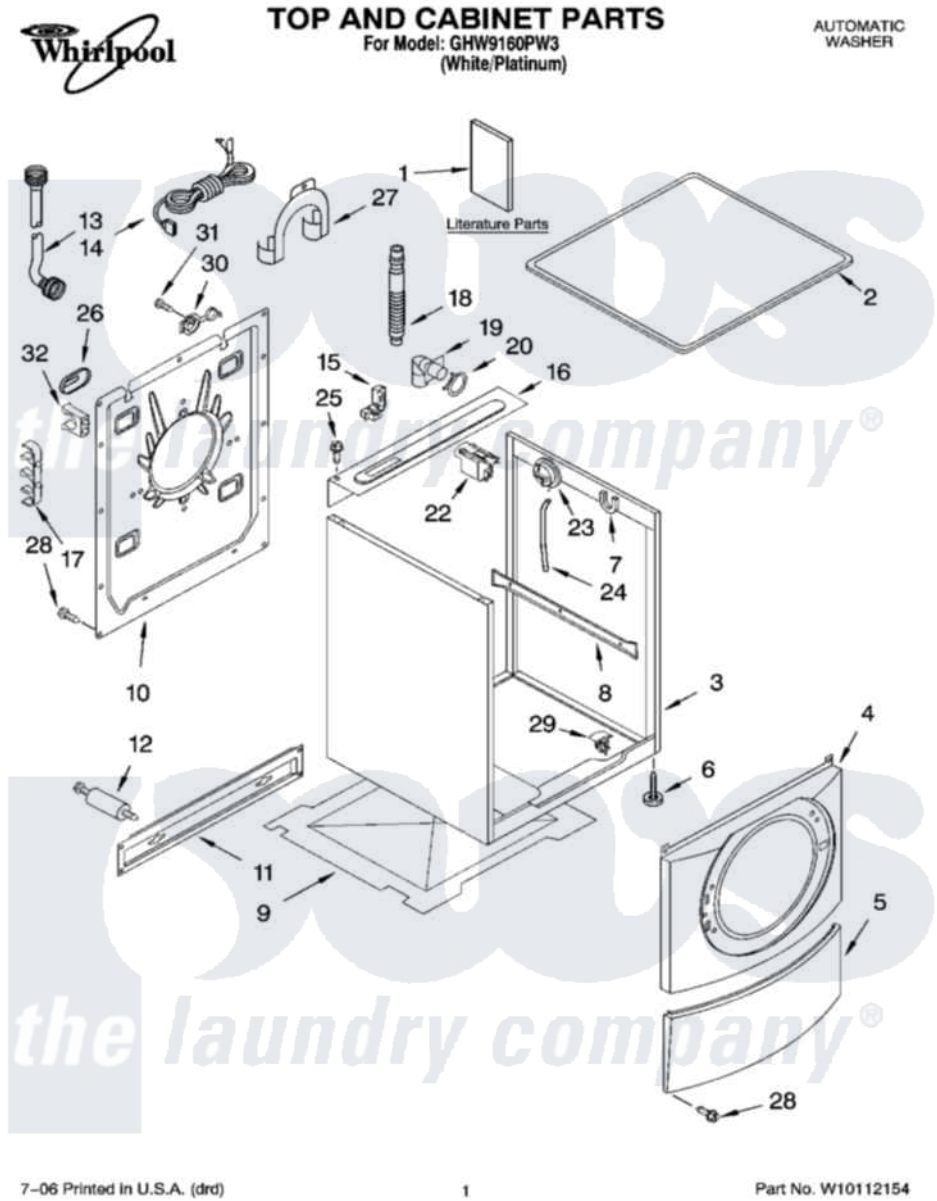

7-06 Printed in U.S.A. (drd)

1

Part No. W10112154

Whirlpool Residential Whirlpool GHW9160PW3 Washer Parts Parts Diagram 01 - TOP AND CABINET PARTS  
 Click on the part number to view part

Item	Original Part Number	Replaced By	Status	Part Description
1	8182748		Not Available	Use & Care Guide
"	<a href="#">8182677</a>			Tech Sheet
"	<a href="#">8182658</a>			Quick Start Guide
"	8182270		Not Available	DVD-Instruction
2	8181799	<a href="#">8181641</a>		Top
3	8181630	<a href="#">8182609</a>		Cabinet
4	<a href="#">8181838</a>			Panel, Front
5	<a href="#">8181643</a>			Toe Panel
6	<a href="#">8181636</a>			Foot, Leveling
7	<a href="#">8181763</a>			Bracket, Spring
8	<a href="#">8183008</a>			Brace, Side Panel
9	<a href="#">8181635</a>			Pan, Bottom
10	<a href="#">8182698</a>			Panel, Rear
11	8182661	<a href="#">W10003040</a>		Brace, Transport
12	8182797	<a href="#">W10289554A</a>		Bolt
"	8182798	<a href="#">W10289554A</a>		Bolt

13	8182795	<a href="#">89503</a>	Hose-Inlet
"	8182792	<a href="#">89503</a>	Hose-Inlet
14	<a href="#">8183009</a>		Cord, Power
15	8181690	<a href="#">8182635</a>	Strain Relief
16	8182607	<a href="#">W10138248</a>	Brace, Rear
17	<a href="#">8182701</a>		Clip, Outer Hose Holder
18	<a href="#">8181737</a>		Hose, Drain
19	<a href="#">8181738</a>		Connector, Hose Outlet
20	8181752	<a href="#">3367052</a>	Clamp, Hose
22	8181683	<a href="#">W10326464</a>	Filter, Interference
23	<a href="#">8181695</a>		Switch, Pressure
24	8181739	<a href="#">W10004260</a>	Hose, Pressure Switch
25	<a href="#">8181691</a>		Screw
26	8182700	<a href="#">8540268</a>	Cover, Transport
27	8181768	<a href="#">W10280024</a>	U-Bend, Drain Hose
28	8181828	<a href="#">488729</a>	Screw
29	8181930	<a href="#">W10085220</a>	Microswitch
30	<a href="#">8182699</a>		Grommet, Cord Support
31	<a href="#">8182201</a>		Screw, 3 X 8 mm
32	<a href="#">8182702</a>		Clip, Outer Hose Holder
"	BLANK	Not Available	Following Parts Not Illustrated
"	<a href="#">8182109</a>		Harness Channel

