

Whirlpool LEQ8621PW2 02 - CABINET PARTS

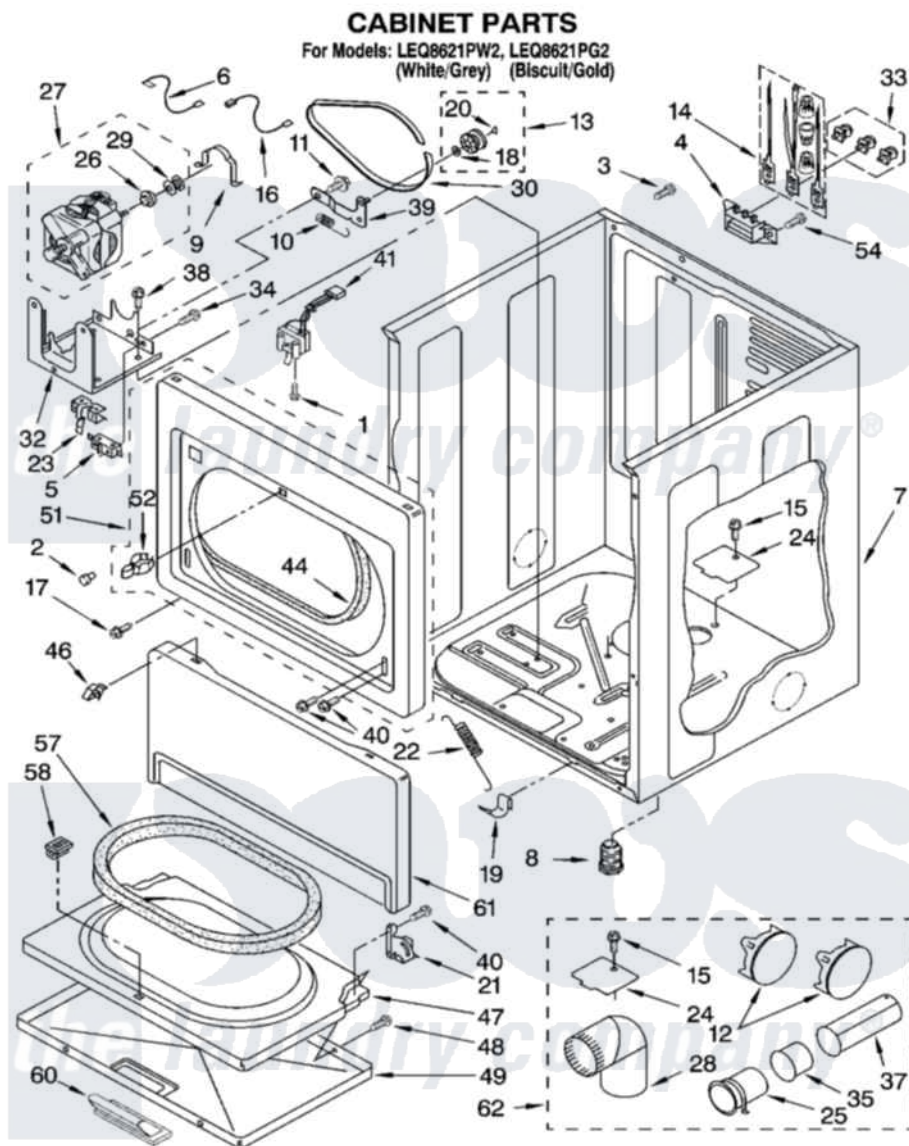

8181041

3

Whirlpool Residential Whirlpool LEQ8621PW2 Dryer Parts Parts Diagram 02 - CABINET PARTS

[Click on the part number to view part](#)

Item	Original Part Number	Replaced By	Status	Part Description
1	697773	3395530		Screw
2	693152			Bumper, Console
3	697776	4331106		Screw, No.10-32 X 7/16
4	3397659			Block, Terminal
5	3394881	279782		Switch-Lid
6	3398948			Wire, Jumper
7	8310656			Cabinet
"	8310659		Not Available	Cabinet (Biscuit)
8	3392100	49621		Feet-Leveling
"	279810			Foot-Optional
9	660658			Clamp, Motor Mounting 343481 685441
10	3387374			Spring, Idler
11	3389420			Retainer-Idler 1/4-20 X 1/16
12	697750	W10470674		Dryer Exhaust Kit
"	3388311			Plug, Multivent
13	3388672	279640		Pulley-Idr

14	279318		Terminal Tinned And Brass Panel
15	693995		Screw, Hex Head
16	3394081		Wire, Broken Belt Switch
17	8281212	W10080800	Screw, 8-18 X 3/8
18	233520		Washer, Thrust
19	297092		Clip
20	690997		Washer, Thrust
21	3387560		Hinge, Door
"	3387559		Hinge, Door
22	3387565		Spring, Door
23	8066120		Lever, Door Switch
24	3394331		Plate Cover
25	3395532		Exhaust Pipe And Bracket
26	3393657		Restrainer, Belt
27	8538263	279787	Motor-Drve
28	49026		4" - 90° Elbow
29	3389729		Pulley, Motor
30	3387610	661570	Belt
32	3387118		Bracket, Motor
33	279393		Terminal Block Screw Kit
34	98129		Screw, 6-20 X 1 1/16
35	3395534		Exhaust Pipe
37	3395535	8563749	Exhaust Pipe
38	3390663	681414	Screw, 10AB X 1/2
39	3388674	W10118756	Idler Bracket
40	3357011	308685	Side Trim)
41	3406107		Door Switch Assembly
44	3387242		Seal, Front Panel
46	3388229		Retainer, Toe Panel
47	697655	280079	Door
48	694091		Trim, Side Right Hand
49	697221		Door, Front
"	3977763		Door, Front
51	697227	279659	Panel
"	3977761	279935	Panel
52	696144	279570	Latch
54	3393008	308685	Side Trim)
57	3390736	3390732	Seal-Door
58	690081	279570	Latch
60	690270	348721	Handle
"	3977242		Handle, Door
61	697215	3406797	Toe Panel
"	3977764	8526025	Toe Panel
62	279818	W10470674	Dryer Exhaust Kit
"	279925	W10470674	Dryer Exhaust Kit