

# Whirlpool LSQ9010LW2 07 - BRAKE AND DRIVE TUBE PARTS

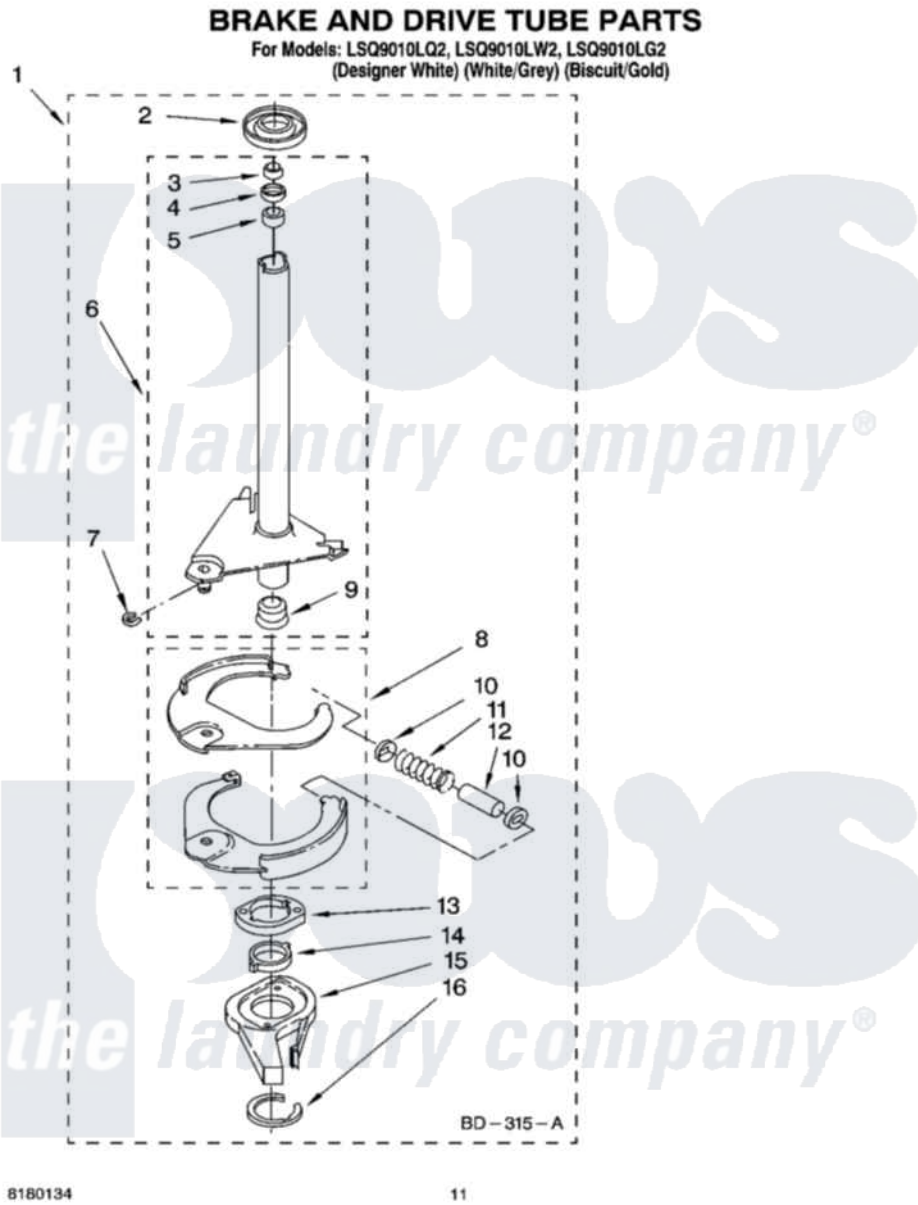

8180134

11

Whirlpool [Residential Whirlpool LSQ9010LW2 Washer Parts](#) Parts Diagram 07 - BRAKE AND DRIVE TUBE PARTS  
Click on the part number to view part

Item	Original Part Number	Replaced By	Status	Part Description
1	388952	<a href="#">285792</a>		Basketdrive
2	<a href="#">62658</a>			Ring, Thrust
3	<a href="#">91939</a>			Seal, Shaft
4	<a href="#">356427</a>			Seal, Spin Pinion
5	<a href="#">356937</a>			Spacer, Drive Tube
6	64027	<a href="#">64208</a>		Tube-Spin
7	64035	<a href="#">W10083190</a>		Ring, Retaining
8	64232	<a href="#">285438</a>		Shoe-Brake
9	62703	<a href="#">8546462</a>		"T" Bearing, Spin Tube
10	62648	<a href="#">285658</a>		Sleeve
11	387806		Not Available	Spring, Brake
12	62909	<a href="#">285658</a>		Sleeve
13	63023	<a href="#">8546461</a>		Cam, Brake Release
14	<a href="#">63022</a>			Sleeve, Cam
15	64194	<a href="#">285790</a>		Lining
16	90368	<a href="#">W10083200</a>		Ring, Retaining

" N/A

Not Available

FOLLOWING PARTS NOT  
ILLUSTRATED

" [285208](#)

Lubricant

