

Whirlpool LSQ9010PW3 08 - GEARCASE PARTS

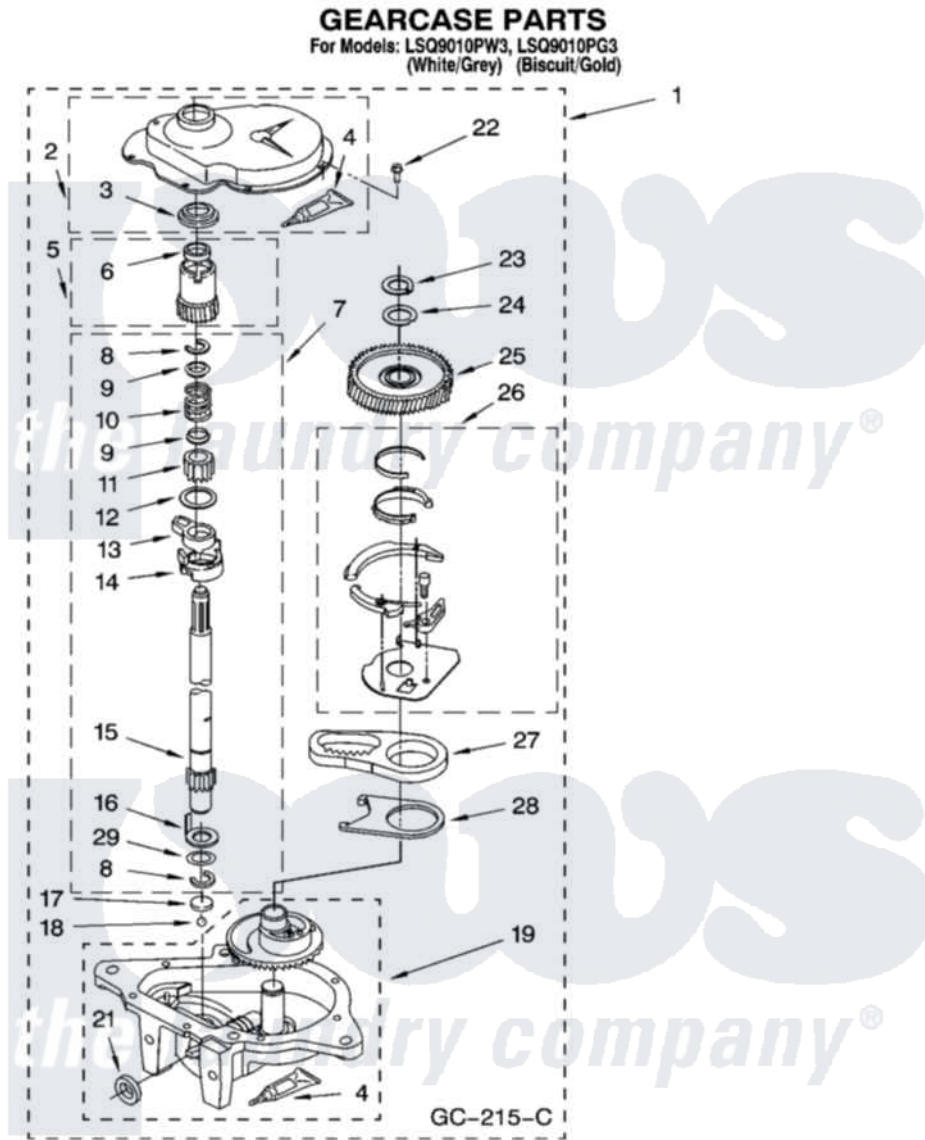

12

8180652

Whirlpool [Residential Whirlpool LSQ9010PW3 Washer Parts](#) Parts Diagram 08 - GEARCASE PARTS
Click on the part number to view part

Item	Original Part Number	Replaced By	Status	Part Description
1	3360630	3360629		Gearcase
2	285202			Cover, Gearcase
3	3349985			Seal, Gearcase Cover
4	285195			Sealer Sealer, Gasket
5	63320	285362		Gear and Pinion
6	356427			Seal, Spin Pinion
7	389387			Shaft, Agitator
8	90369		Not Available	Ring, Retaining (2)
9	62677			Retainer, Spring
10	62676			Spring, Agitator
11	63273	285509		Shaft, Agitator
12	62619			Washer, Agitator Gear
13	62580	285206		Cam-Agitator
14	62581	285206		Cam-Agitator
15	285509			Shaft, Agitator
16	62618			Washer, Cam Thrust

17	16018	285205	Bearing
18	85529	285205	Bearing
19	389230	285515	Gearcase
21	285352		Seal Kit, Thrust Plug
22	3351614		Screw, Gearcase Cover Mounting
23	3362552	285765	Ring-Retr
24	285735	285766	Washer Kit, Thrust
25	62570	285362	Gear and Pinon
26	388253	999516	Shelf-Glas
27	3349296	8546456	Rack, Connecting
28	62621		Actuator, Shift
29	388815		Washer, Intermediate 1 3976263 Miscellaneous Parts Bag 2 3976300 Washer, Inlet Hose 3 3366913 Clamp, Hose

