

Whirlpool LSQ9549LW1 04 - MACHINE BASE PARTS

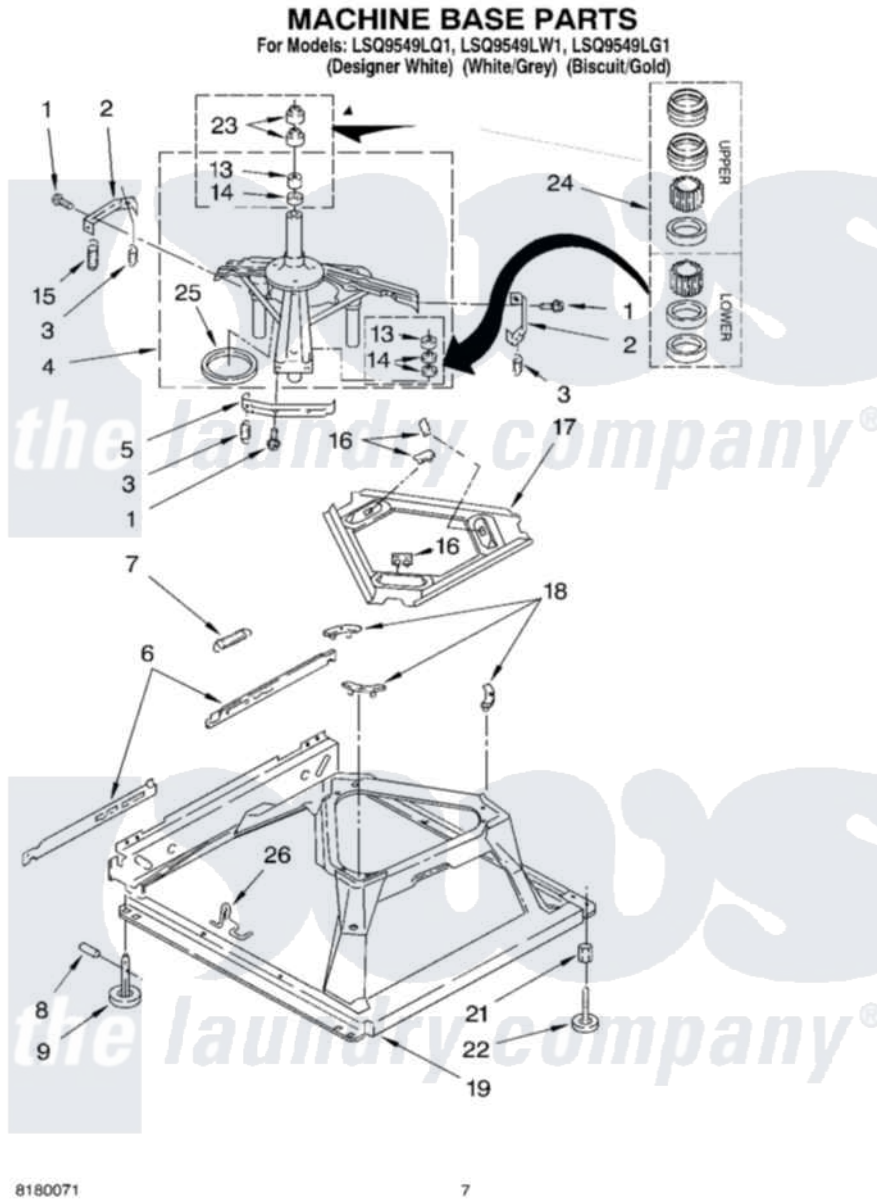

Whirlpool [Residential Whirlpool LSQ9549LW1 Washer Parts](#) Parts Diagram 04 - MACHINE BASE PARTS
Click on the part number to view part

Item	Original Part Number	Replaced By	Status	Part Description
1	3400076			Screw, Bracket Mounting
2	64067			Bracket, Spring Outer
3	63907			Spring, Suspension
4	3362087	280184		Support
5	64065			Bracket, Spring Outer
6	63466			Link, Leveling Mechanism
7	62597	8316845		Spring
8	62837			Pin, Knurled
9	62596	285244		Feet-Leveling
13	3347047	8546455		Bearing, Centerpost
14	357409	359449		Seal, Agitator Shaft
15	388492	W10250667		Spring, Counterweight
16	62568	285219		Pad
17	3946509			Plate, Suspension
18	3363660	285744		Pad
19	3946512	285771		Base

21	3359452		Nut, Lock
22	389102	W10001130	Foot, Leveling
23	356934	8577376	Seal, Centerpost
24	285203		Centerpost Bearing Kit
25	63134		Ring, Sound Deadening
26	63806	W10145155	Retainer, Suspension Spring

