

# Whirlpool LSQ9660PW2 08 - GEARCASE PARTS

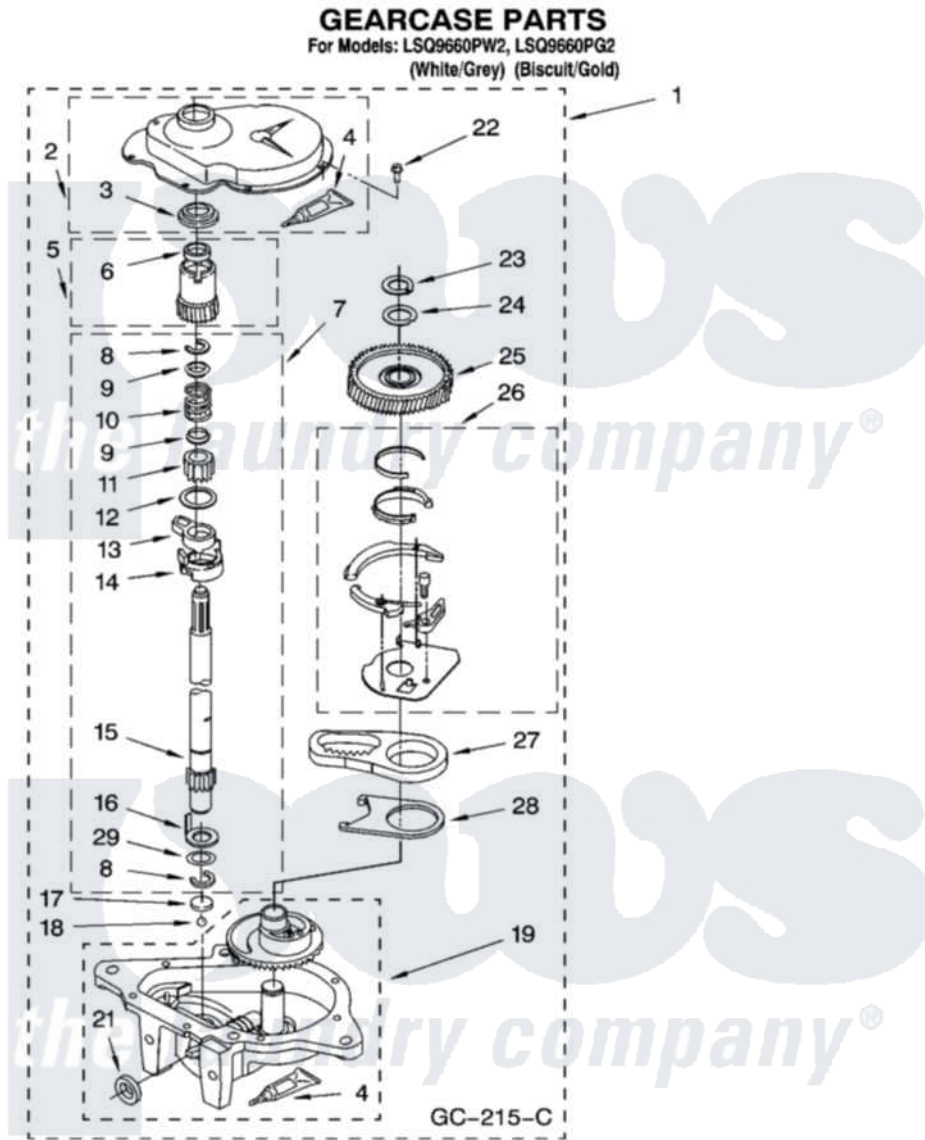

12

8180590

Whirlpool [Residential Whirlpool LSQ9660PW2 Washer Parts](#) Parts Diagram 08 - GEARCASE PARTS  
Click on the part number to view part

Item	Original Part Number	Replaced By	Status	Part Description
1	3360630	<a href="#">3360629</a>		Gearcase
2	<a href="#">285202</a>			Cover, Gearcase
3	<a href="#">3349985</a>			Seal, Gearcase Cover
4	<a href="#">285195</a>			Sealer Sealer, Gasket
5	63320	<a href="#">285362</a>		Gear and Pinion
6	<a href="#">356427</a>			Seal, Spin Pinion
7	<a href="#">389387</a>			Shaft, Agitator
8	90369		Not Available	Ring, Retaining (2)
9	<a href="#">62677</a>			Retainer, Spring
10	<a href="#">62676</a>			Spring, Agitator
11	63273	<a href="#">285509</a>		Shaft, Agitator
12	<a href="#">62619</a>			Washer, Agitator Gear
13	62580	<a href="#">285206</a>		Cam-Agitator
14	62581	<a href="#">285206</a>		Cam-Agitator
15	<a href="#">285509</a>			Shaft, Agitator
16	<a href="#">62618</a>			Washer, Cam Thrust

17	16018	<a href="#">285205</a>	Bearing
18	85529	<a href="#">285205</a>	Bearing
19	389230	<a href="#">285515</a>	Gearcase
21	<a href="#">285352</a>		Seal Kit, Thrust Plug
22	<a href="#">3351614</a>		Screw, Gearcase Cover Mounting
23	3362552	<a href="#">285765</a>	Ring-Retr
24	285735	<a href="#">285766</a>	Washer Kit, Thrust
25	62570	<a href="#">285362</a>	Gear and Pinon
26	388253	<a href="#">999516</a>	Shelf-Glas
27	3349296	<a href="#">8546456</a>	Rack, Connecting
28	<a href="#">62621</a>		Actuator, Shift
29	<a href="#">388815</a>		Washer, Intermediate 1 3976263 Miscellaneous Parts Bag 2 3976300 Washer, Inlet Hose 3 3366913 Clamp, Hose

