

# Whirlpool LSR9434PT0 05 - MACHINE BASE PARTS

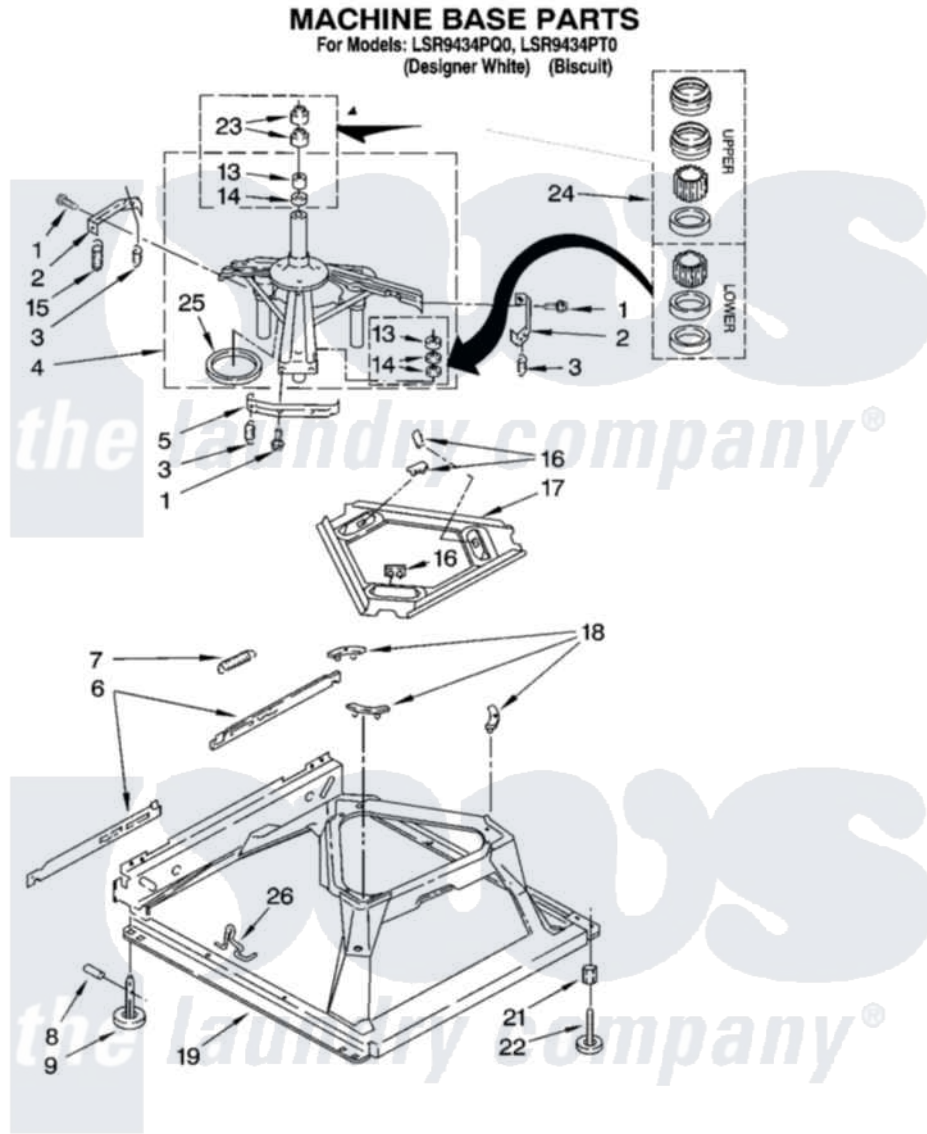

8

8180378

Whirlpool [Residential Whirlpool LSR9434PT0 Washer Parts](#) Parts Diagram 05 - MACHINE BASE PARTS  
 Click on the part number to view part

Item	Original Part Number	Replaced By	Status	Part Description
1	<a href="#">3400076</a>			Screw, Bracket Mounting
2	<a href="#">64067</a>			Bracket, Spring Outer
3	<a href="#">63907</a>			Spring, Suspension
4	3362087	<a href="#">280184</a>		Support
5	<a href="#">64065</a>			Bracket, Spring Outer
6	<a href="#">63466</a>			Link, Leveling Mechanism
7	62597	<a href="#">8316845</a>		Spring
8	<a href="#">62837</a>			Pin, Knurled
9	62596	<a href="#">285244</a>		Feet-Leveling
13	3347047	<a href="#">8546455</a>		Bearing, Centerpost
14	357409	<a href="#">359449</a>		Seal, Agitator Shaft
15	388492	<a href="#">W10250667</a>		Spring, Counterweight
16	62568	<a href="#">285219</a>		Pad
17	<a href="#">3946509</a>			Plate, Suspension
18	3363660	<a href="#">285744</a>		Pad
19	3946512	<a href="#">285771</a>		Base

21	<a href="#">3359452</a>		Nut, Lock
22	389102	<a href="#">W10001130</a>	Foot, Leveling
23	356934	<a href="#">8577376</a>	Seal, Centerpost
24	<a href="#">285203</a>		Centerpost Bearing Kit
25	<a href="#">63134</a>		Ring, Sound Deadening
26	63806	<a href="#">W10145155</a>	Retainer, Suspension Spring

