

# Whirlpool LTG6234DQ3 06 - WASHER TOP AND LID PARTS

## WASHER TOP AND LID PARTS

For Models: LTG6234DQ3, LTG6234DT3  
(Designer White) (Biscuit)

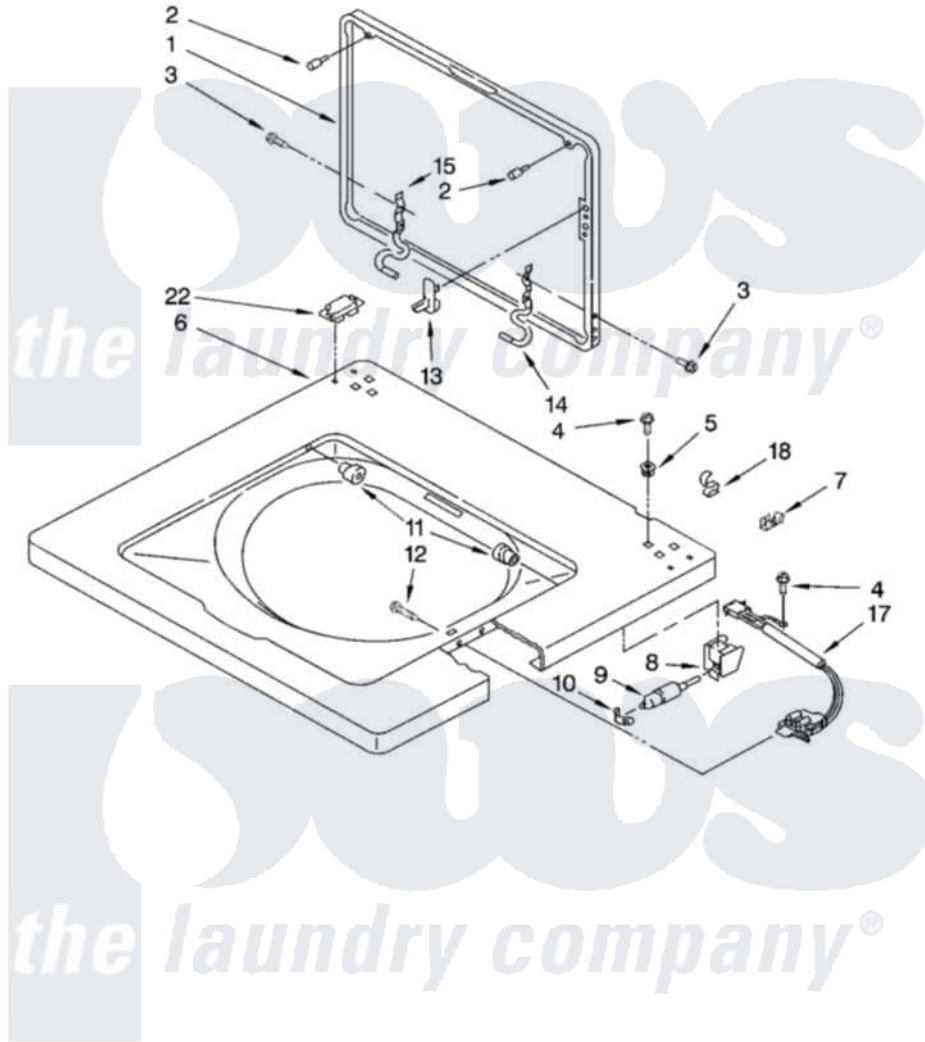

8180809

9

Whirlpool [Residential Whirlpool LTG6234DQ3 Washer/Dryer Parts](#) Parts Diagram 06 - WASHER TOP AND LID PARTS  
Click on the part number to view part

Item	Original Part Number	Replaced By	Status	Part Description
1	3351652	<a href="#">W10193874</a>		Lid
"	3351666	<a href="#">3957566</a>		Lid
2	<a href="#">9724509</a>			Bumper, Lid
3	3351355	<a href="#">W10119828</a>		Screw, Lid Hinge Mounting
4	343641	<a href="#">681414</a>		Screw, 10AB X 1/2
5	<a href="#">692400</a>			Nut, Push-In
6	<a href="#">3349798</a>			Top, Console
"	<a href="#">3349803</a>			Top, Console
7	357572	<a href="#">W10113937</a>		Clip, Grounding
8	<a href="#">3354020</a>			Bracket, Mounting
9	<a href="#">3350152</a>			Retainer, Lid Assembly
10	<a href="#">3350828</a>			Clip-Cylinder Retainer
11	<a href="#">21258</a>			Bearing, Lid Hinge
12	<a href="#">3356311</a>			Screw And Washer, Lid Switch Shield
13	<a href="#">358684</a>			Strike, Lid Switch
14	<a href="#">3350101</a>			Hinge, RH

15	<a href="#">3350102</a>		Hinge, L.H.
17	<a href="#">3355458</a>		Switch, Lid
18	<a href="#">90016</a>		Clip, Pressure Switch Hose
22	3390481	<a href="#">W10134768</a>	Locator, Top

